



SGS-THOMSON
 MICROELECTRONICS

TXN/TYN 058,G,K → 1008,G,K

S G S-THOMSON

THYRISTORS

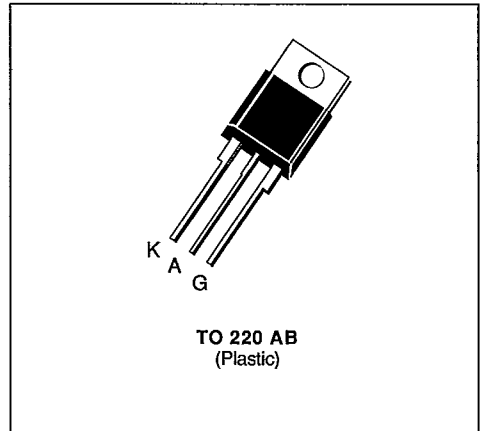
- GLASS PASSIVATED CHIP
- POSSIBILITY OF MOUNTING ON PRINTED CIRCUIT
- AVAILABLE IN NON-INSULATED VERSION → TYN SERIES OR IN INSULATED VERSION → TXN SERIES (INSULATING VOLTAGE 2500 V_{RMS})
- UL RECOGNIZED FOR TXN SERIES (E81734)

 TO 220 AB
 (Plastic)

DESCRIPTION

SCR's designed for motor control, heating controls, power supplies...

ABSOLUTE RATINGS (limiting values)

Symbol	Parameter		Value	Unit
$I_{T(RMS)}$	RMS on-state Current (1)	$T_c = 75\text{ }^\circ\text{C}$	8	A
$I_{T(AV)}$	Mean on-state Current (1)	$T_c = 75\text{ }^\circ\text{C}$	5	A
I_{TSM}	Non Repetitive Surge Peak on-state Current (T_j initial = 25 °C) (2)	$t = 8.3\text{ ms}$	84	A
		$t = 10\text{ ms}$	80	
I^2t	I^2t Value for Fusing	$t = 10\text{ ms}$	32	A ² s
dI/dt	Critical Rate of Rise of on-state Current (3)		50	A/ μ s
T_{stg} T_j	Storage and Operating Junction Temperature Range		- 40 to 110	°C
			- 40 to 110	°C

Symbol	Parameter	TXN/TYN ..., G, K						Unit	
		058	108	208	408	608	808		1008
V_{DRM} V_{RRM}	Repetitive Peak off-state Voltage (4)	50	100	200	400	600	800	1000	V

(1) Single phase circuit, 180° conduction angle.

(2) Half sine wave.

 (3) $I_G = 400\text{ mA}$ $di/dt = 1\text{ A}/\mu\text{s}$.

 (4) $T_j = 110\text{ }^\circ\text{C}$.

THERMAL RESISTANCES

Symbol	Parameter	Value	Unit
$R_{th(j-c)}$	Junction-case for D.C.	4.7	°C/W
$R_{th(j-a)}$	Junction-ambient	60	°C/W

30E D ■ 7929237 0031441 5 ■

T-25-15

GATE CHARACTERISTICS (maximum values)

$P_{GM} = 20 \text{ W}$ ($t_p = 20 \mu\text{s}$) $I_{FGM} = 2 \text{ A}$ ($t_p = 20 \mu\text{s}$) $V_{RGM} = 5 \text{ V}$
 $P_{G(AV)} = 0.5 \text{ W}$ $V_{FGM} = 15 \text{ V}$ ($t_p = 20 \mu\text{s}$)

ELECTRICAL CHARACTERISTICS

Symbol	Test Conditions	Min.	Typ.	Max.	Unit
I_{GT}	$T_j = 25 \text{ }^\circ\text{C}$ $V_D = 12 \text{ V}$ $R_L = 33 \text{ } \Omega$ Pulse Duration > 20 μs	Without Suffix		15	mA
		Suffix G		25	
		Suffix K		40	
V_{GT}	$T_j = 25 \text{ }^\circ\text{C}$ $V_D = 12 \text{ V}$ $R_L = 33 \text{ } \Omega$ Pulse Duration > 20 μs			1.5	V
V_{GD}	$T_j = 110 \text{ }^\circ\text{C}$ $V_D = V_{DRM}$ $R_L = 3.3 \text{ k}\Omega$	0.2			V
I_H	$T_j = 25 \text{ }^\circ\text{C}$ $I_T = 100 \text{ mA}$ Gate Open	Without Suffix		30	mA
		Suffix G		45	
		Suffix K		60	
I_L	$T_j = 25 \text{ }^\circ\text{C}$ $V_D = 12 \text{ V}$ $I_G = 80 \text{ mA}$ Pulse Duration > 20 μs		50		mA
V_{TM}	$T_j = 25 \text{ }^\circ\text{C}$ $I_{TM} = 16 \text{ A}$ $t_p = 10 \text{ ms}$			1.6	V
I_{DRM}	V_{DRM} Specified	$T_j = 25 \text{ }^\circ\text{C}$		0.01	mA
		$T_j = 110 \text{ }^\circ\text{C}$		1	
I_{RRM}	V_{RRM} Specified	$T_j = 25 \text{ }^\circ\text{C}$		0.01	mA
		$T_j = 110 \text{ }^\circ\text{C}$		1	
t_{gt}	$T_j = 25 \text{ }^\circ\text{C}$ $V_D = V_{DRM}$ $I_G = 40 \text{ mA}$ $di/dt = 0.45 \text{ A}/\mu\text{s}$		2		μs
t_q	$T_j = 110 \text{ }^\circ\text{C}$ $I_T = 16 \text{ A}$ $V_D = 67 \% V_{DRM}$ $di/dt = 30 \text{ A}/\mu\text{s}$ $dv/dt = 50 \text{ V}/\mu\text{s}$		70		μs
dv/dt^*	$T_j = 110 \text{ }^\circ\text{C}$ Gate Open Linear Slope up to $V_D = 67 \% V_{DRM}$	Without Suffix	200		V/ μs
		Suffix G	500		
		Suffix K	750		

* For higher guaranteed values, please consult us.

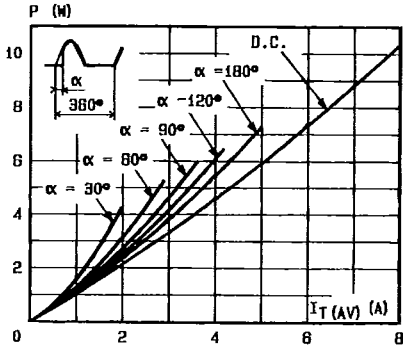

Fig. 1 - Maximum mean power dissipation versus mean on-state current.

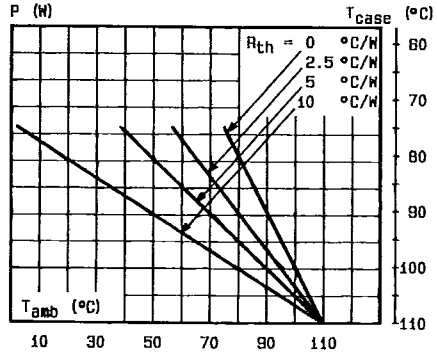

Fig. 2 - Correlation between maximum mean power dissipation and maximum allowable temperatures (T_{amb} and T_{case}) for different thermal resistances heatsink + contact.

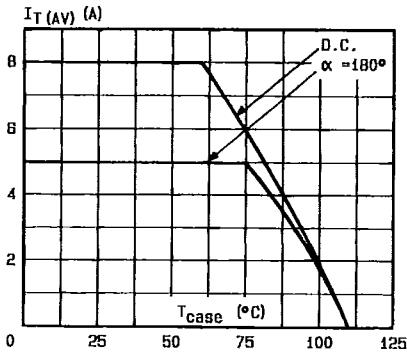

Fig. 3 - Mean on-state current versus case temperature.

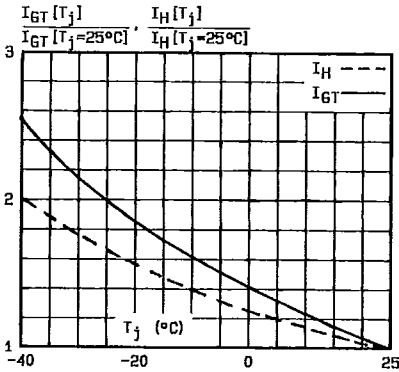

Fig. 5 - Relative variation of gate trigger current and holding current versus junction temperature.

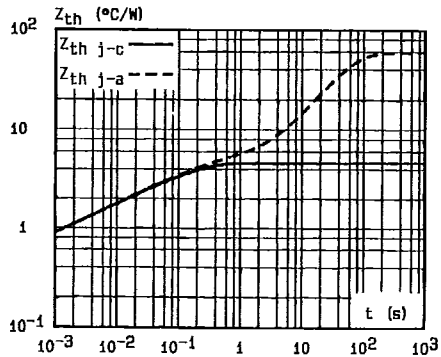

Fig. 4 - Thermal transient impedance junction to case and junction to ambient versus pulse duration.

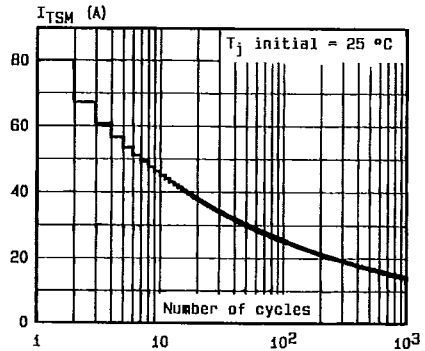

Fig. 6 - Non repetitive surge peak on-state current versus number of cycles.

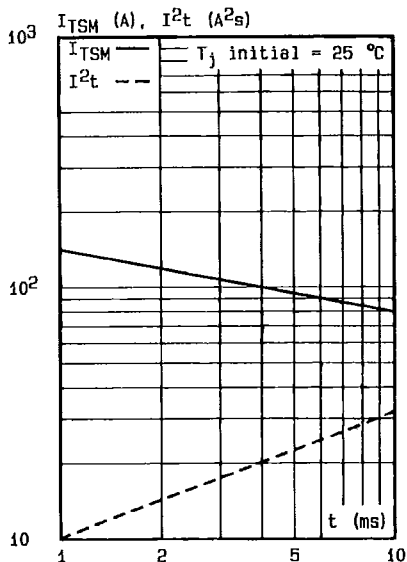

Fig.7 - Non repetitive surge peak on-state current for a sinusoidal pulse with width : $t \leq 10$ ms, and corresponding value of I^2t .

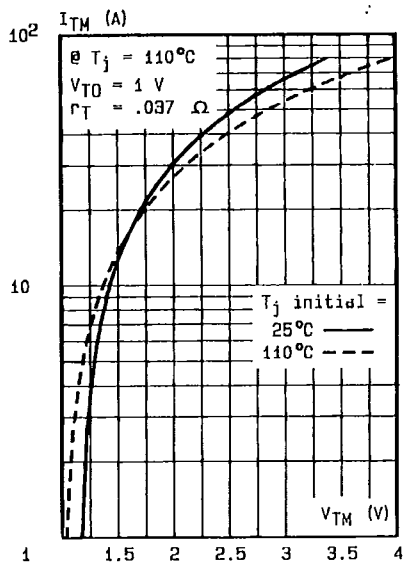
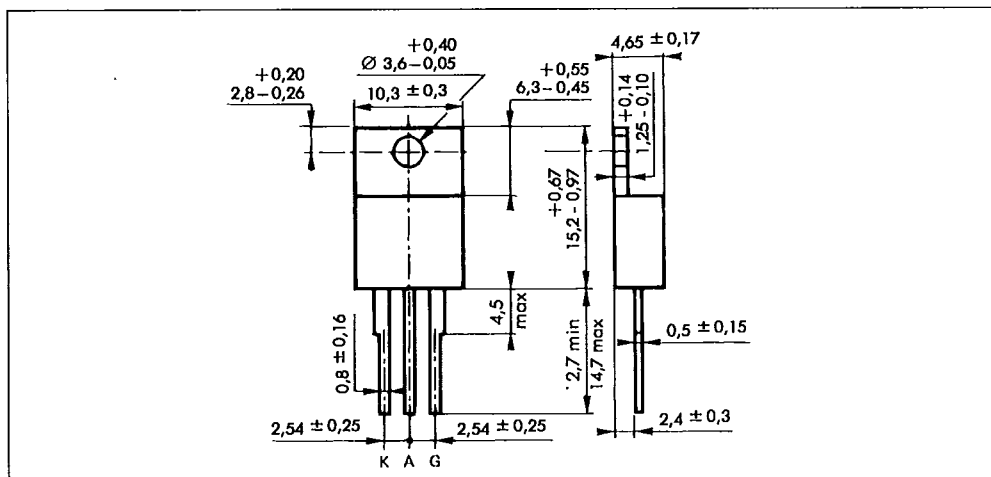

Fig.8 - On-state characteristics (maximum values).

PACKAGE MECHANICAL DATA : TO 220 AB Plastic



Cooling method : by conduction (method C)
 Marking : type number
 Weight : 2 g

30E D ■ 7929237 0031443 9 ■