



## 2SD613

## NPN EPITAXIAL SILICON TRANSISTOR

### LOW FREQUENCY POWER AMPLIFIER

- Complement to 2SB633

### ABSOLUTE MAXIMUM RATINGS ( $T_A=25^\circ\text{C}$ )

Characteristic	Symbol	Rating	Unit
Collector-Base Voltage	$V_{CB0}$	100	V
Collector-Emitter Voltage	$V_{CE0}$	85	V
Emitter-Base voltage	$V_{EB0}$	5	V
Collector Current (DC)	$I_C$	6	A
Collector Dissipation ( $T_c=25^\circ\text{C}$ )	$P_C$	40	W
Junction Temperature	$T_j$	150	$^\circ\text{C}$
Storage Temperature	$T_{stg}$	-50~150	$^\circ\text{C}$

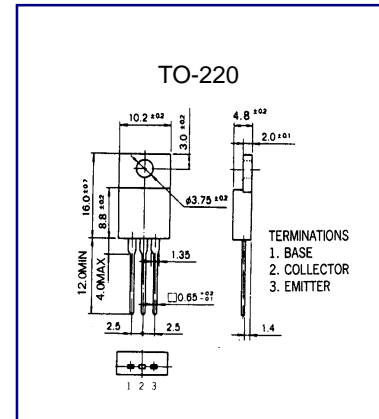

### ELECTRICAL CHARACTERISTICS ( $T_A=25^\circ\text{C}$ )

Characteristic	Symbol	Test Condition	Min	Typ	Max	Unit
Collector Cutoff Current	$I_{CBO}$	$V_{CB}=100\text{V}, I_E=0$			10	$\mu\text{A}$
Emitter Cutoff Current	$I_{EBO}$	$V_{EB}=5\text{V}, I_C=0$			10	$\mu\text{A}$
DC Current Gain	$h_{FE1}$	$V_{CE}=5\text{V}, I_C=1\text{A}$	40		320	
Collector- Emitter Saturation Voltage	$V_{CE(sat)}$	$I_C=4\text{A}, I_B=0.4\text{A}$			2.0	V
Current Gain Bandwidth Product	$f_T$	$V_{CE}=2\text{V}, I_C=0.5\text{A}$		8		MHZ

This datasheet has been download from:

[www.datasheetcatalog.com](http://www.datasheetcatalog.com)

Datasheets for electronics components.