

# 2SD1133, 2SD1134

Silicon NPN Triple Diffused

# HITACHI

ADE-208-905 (Z)  
1st. Edition  
Sep. 2000

## Application

Low frequency power amplifier complementary pair with 2SB857 and 2SB858

## Outline

TO-220AB

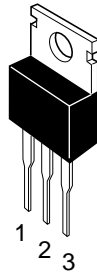

1. Base
2. Collector (Flange)
3. Emitter

## Absolute Maximum Ratings (Ta = 25°C)

Item	Symbol	Ratings		Unit
		2SD1133	2SD1134	
Collector to base voltage	$V_{CBO}$	70	70	V
Collector to emitter voltage	$V_{CEO}$	50	60	V
Emitter to base voltage	$V_{EBO}$	5	5	V
Collector current	$I_C$	4	4	A
Collector peak current	$I_{C(peak)}$	8	8	A
Collector power dissipation	$P_C^{*1}$	40	40	W
Junction temperature	$T_j$	150	150	°C
Storage temperature	$T_{stg}$	-45 to +150	-45 to +150	°C

Note: 1. Value at  $T_C = 25^\circ\text{C}$ .

# 2SD1133, 2SD1134

## Electrical Characteristics (Ta = 25°C)

Item	Symbol	2SD1133			2SD1134			Unit	Test conditions
		Min	Typ	Max	Min	Typ	Max		
Collector to base breakdown voltage	$V_{(BR)CBO}$	70	—	—	70	—	—	V	$I_C = 10 \mu A, I_E = 0$
Collector to emitter breakdown voltage	$V_{(BR)CEO}$	50	—	—	60	—	—	V	$I_C = 50 \text{ mA}, R_{BE} = \infty$
Emitter to base breakdown voltage	$V_{(BR)EBO}$	5	—	—	5	—	—	V	$I_E = 10 \mu A, I_C = 0$
Collector cutoff current	$I_{CBO}$	—	—	1	—	—	1	$\mu A$	$V_{CB} = 50 \text{ V}, I_E = 0$
DC current transfer ratio	$h_{FE1}^{*1}$	60	—	320	60	—	320		$V_{CE} = 4 \text{ V}, I_C = 1 \text{ A}^{*2}$
	$h_{FE2}$	35	—	—	35	—	—		$I_C = 0.1 \text{ A}^{*2}$
Collector to emitter saturation voltage	$V_{CE(sat)}$	—	—	1	—	—	1	V	$I_C = 2 \text{ A}, I_B = 0.2 \text{ A}^{*2}$
Base to emitter voltage	$V_{BE}$	—	—	1	—	—	1	V	$V_{CE} = 4 \text{ V}, I_C = 1 \text{ A}^{*2}$
Gain bandwidth product	$f_T$	—	7	—	—	7	—	MHz	$V_{CE} = 4 \text{ V}, I_C = 0.5 \text{ A}^{*2}$

Notes: 1. The 2SD1133 and 2SD1134 are grouped by  $h_{FE1}$  as follows.

2. Pulse test.

B	C	D
60 to 120	100 to 200	160 to 320

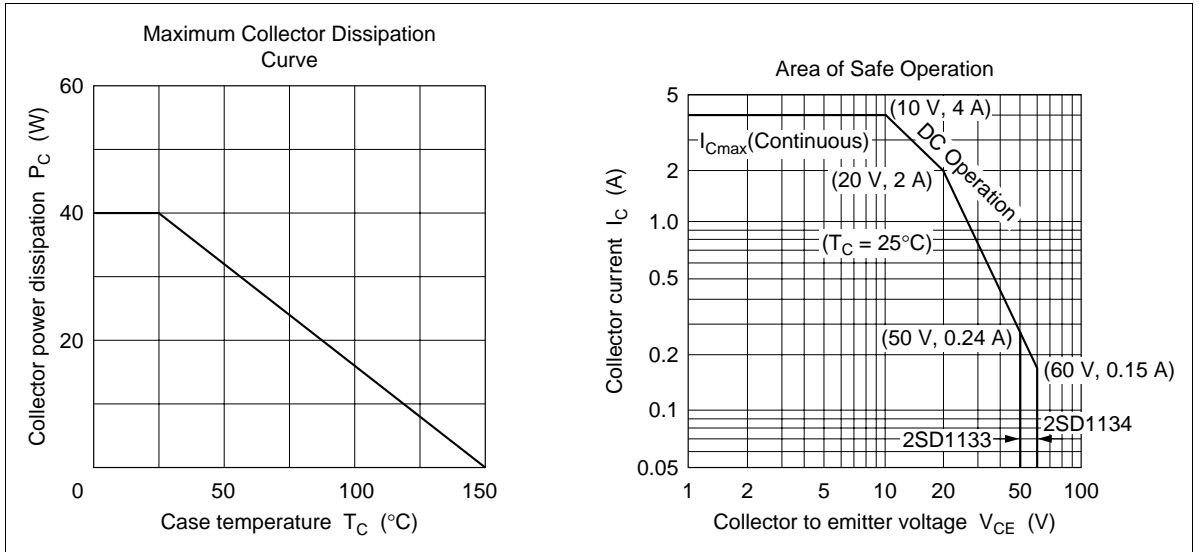

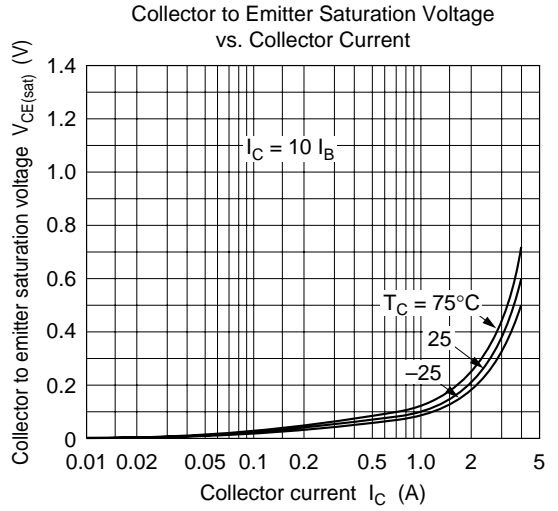
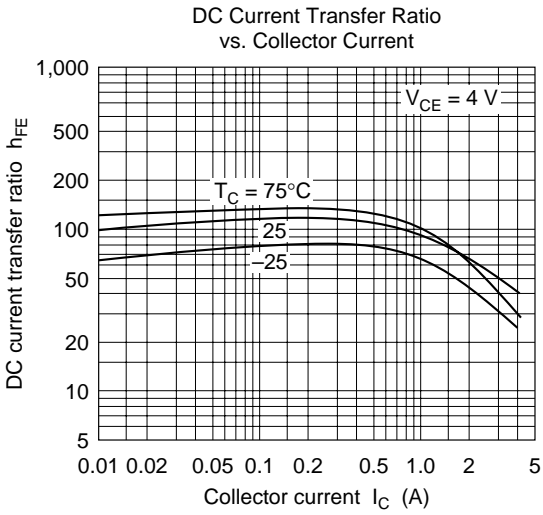
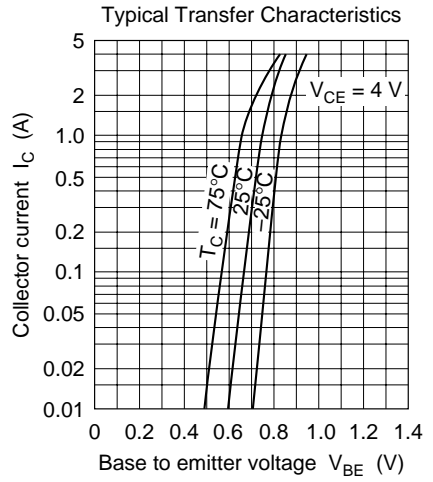
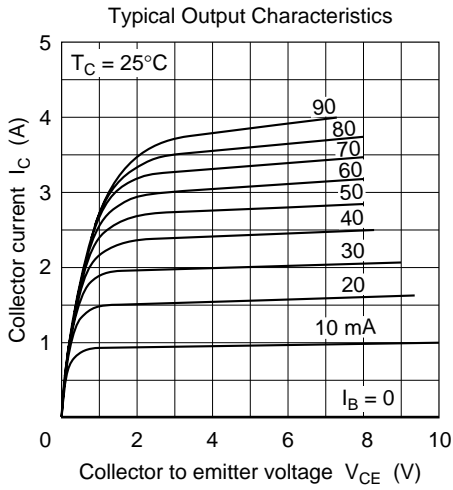

Package Dimensions

Unit: mm

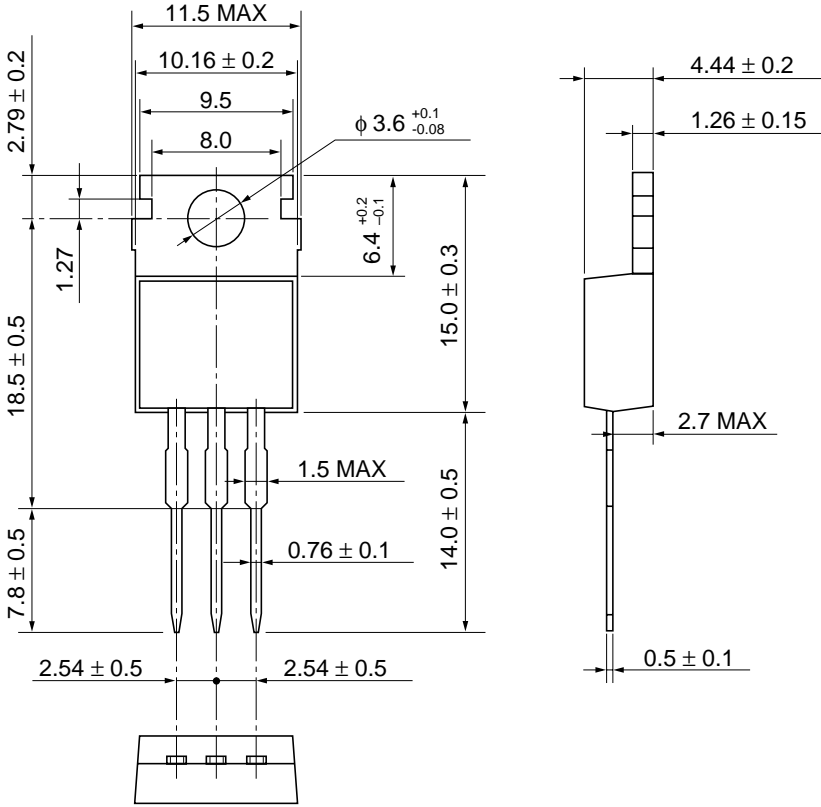

Hitachi Code	TO-220AB
JEDEC	Conforms
EIAJ	Conforms
Mass (reference value)	1.8 g

## Cautions

1. Hitachi neither warrants nor grants licenses of any rights of Hitachi's or any third party's patent, copyright, trademark, or other intellectual property rights for information contained in this document. Hitachi bears no responsibility for problems that may arise with third party's rights, including intellectual property rights, in connection with use of the information contained in this document.
2. Products and product specifications may be subject to change without notice. Confirm that you have received the latest product standards or specifications before final design, purchase or use.
3. Hitachi makes every attempt to ensure that its products are of high quality and reliability. However, contact Hitachi's sales office before using the product in an application that demands especially high quality and reliability or where its failure or malfunction may directly threaten human life or cause risk of bodily injury, such as aerospace, aeronautics, nuclear power, combustion control, transportation, traffic, safety equipment or medical equipment for life support.
4. Design your application so that the product is used within the ranges guaranteed by Hitachi particularly for maximum rating, operating supply voltage range, heat radiation characteristics, installation conditions and other characteristics. Hitachi bears no responsibility for failure or damage when used beyond the guaranteed ranges. Even within the guaranteed ranges, consider normally foreseeable failure rates or failure modes in semiconductor devices and employ systemic measures such as fail-safes, so that the equipment incorporating Hitachi product does not cause bodily injury, fire or other consequential damage due to operation of the Hitachi product.
5. This product is not designed to be radiation resistant.
6. No one is permitted to reproduce or duplicate, in any form, the whole or part of this document without written approval from Hitachi.
7. Contact Hitachi's sales office for any questions regarding this document or Hitachi semiconductor products.

# HITACHI

## Hitachi, Ltd.

Semiconductor & Integrated Circuits.  
Nippon Bldg., 2-6-2, Ohte-machi, Chiyoda-ku, Tokyo 100-0004, Japan  
Tel: Tokyo (03) 3270-2111 Fax: (03) 3270-5109

URL	North America	: <a href="http://semiconductor.hitachi.com/">http://semiconductor.hitachi.com/</a>
	Europe	: <a href="http://www.hitachi-eu.com/hel/ecg">http://www.hitachi-eu.com/hel/ecg</a>
	Asia	: <a href="http://sicapac.hitachi-asia.com">http://sicapac.hitachi-asia.com</a>
	Japan	: <a href="http://www.hitachi.co.jp/Sicd/indx.htm">http://www.hitachi.co.jp/Sicd/indx.htm</a>

### For further information write to:

Hitachi Semiconductor  
(America) Inc.  
179 East Tasman Drive,  
San Jose, CA 95134  
Tel: <1> (408) 433-1990  
Fax: <1> (408) 433-0223

Hitachi Europe GmbH  
Electronic Components Group  
Dornacher Straße 3  
D-85622 Feldkirchen, Munich  
Germany  
Tel: <49> (89) 9 9180-0  
Fax: <49> (89) 9 29 30 00

Hitachi Europe Ltd.  
Electronic Components Group.  
Whitebrook Park  
Lower Cookham Road  
Maidenhead  
Berkshire SL6 8YA, United Kingdom  
Tel: <44> (1628) 585000  
Fax: <44> (1628) 585160

Hitachi Asia Ltd.  
Hitachi Tower  
16 Collyer Quay #20-00,  
Singapore 049318  
Tel: <65>-538-6533/538-8577  
Fax : <65>-538-6933/538-3877  
URL : <http://www.hitachi.com.sg>

Hitachi Asia Ltd.  
(Taipei Branch Office)  
4/F, No. 167, Tun Hwa North Road,  
Hung-Kuo Building,  
Taipei (105), Taiwan  
Tel: <886>-(2)-2718-3666  
Fax : <886>-(2)-2718-8180  
Telex : 23222 HAS-TP  
URL : <http://www.hitachi.com.tw>

Hitachi Asia (Hong Kong) Ltd.  
Group III (Electronic Components)  
7/F., North Tower,  
World Finance Centre,  
Harbour City, Canton Road  
Tsim Sha Tsui, Kowloon,  
Hong Kong  
Tel : <852>-(2)-735-9218  
Fax : <852>-(2)-730-0281  
URL : <http://www.hitachi.com.hk>

Copyright © Hitachi, Ltd., 2000. All rights reserved. Printed in Japan.  
Colophon 2.0

This datasheet has been download from:

[www.datasheetcatalog.com](http://www.datasheetcatalog.com)

Datasheets for electronics components.