

TOSHIBA TRANSISTOR SILICON NPN EPITAXIAL TYPE (PCT PROCESS)

2SC941TM

HIGH FREQUENCY AMPLIFIER APPLICATIONS.
 AM HIGH FREQUENCY AMPLIFIER APPLICATIONS.
 AM FREQUENCY CONVERTER APPLICATIONS.

Unit in mm

- Low Noise Figure : NF=3.5dB (Max.) (f=1MHz)

MAXIMUM RATINGS (Ta = 25°C)

CHARACTERISTIC	SYMBOL	RATING	UNIT
Collector-Base Voltage	V _{CB0}	35	V
Collector-Emitter Voltage	V _{CEO}	30	V
Emitter-Base Voltage	V _{EB0}	4	V
Collector Current	I _C	100	mA
Base Current	I _B	20	mA
Collector Power Dissipation	P _C	400	mW
Junction Temperature	T _j	125	°C
Storage Temperature Range	T _{stg}	-55~125	°C

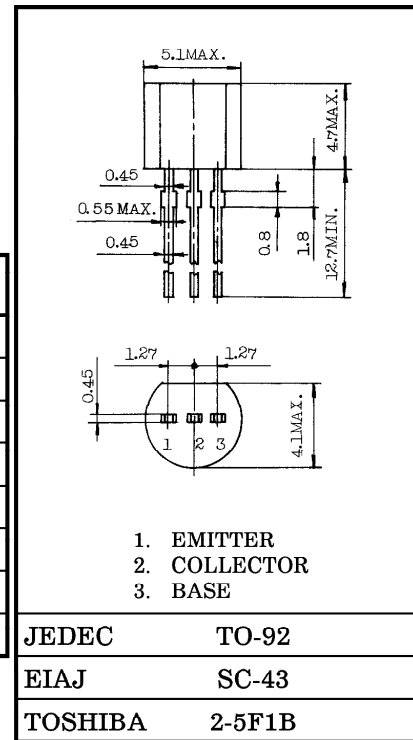

Weight : 0.21g

ELECTRICAL CHARACTERISTICS (Ta = 25°C)

CHARACTERISTIC	SYMBOL	TEST CONDITION	MIN.	TYP.	MAX.	UNIT
Collector Cut-off Current	I _{CB0}	V _{CB} = 20V, I _E = 0	—	—	0.1	μA
Emitter Cut-off Current	I _{EB0}	V _{EB} = 2V, I _C = 0	—	—	1.0	μA
DC Current Gain	h _{FE} (Note)	V _{CE} = 12V, I _C = 2mA	40	—	240	—
Collector-Emitter Saturation Voltage	V _{CE(sat)}	I _C = 10mA, I _B = 1mA	—	—	0.4	V
Base-Emitter Saturation Voltage	V _{BE(sat)}	I _C = 10mA, I _B = 1mA	—	—	1.0	V
Transition Frequency	f _T	V _{CE} = 10V, I _C = 2mA	80	120	—	MHz
Reverse Transfer Capacitance	C _{re}	V _{CB} = 10V, I _E = 0, f = 1MHz	—	2.2	3.0	pF
Collector-Base Time Constant	C _{c-rbb'}	V _{CE} = 10V, I _E = -1mA, f = 30MHz	—	30	50	ps
Noise Figure	NF	V _{CE} = 10V, I _E = -1mA, f = 1MHz, R _g = 50Ω	—	2.0	3.5	dB

Note : h_{FE} classification R : 40~80, O : 70~140, Y : 120~240

961001EAA2

● TOSHIBA is continually working to improve the quality and the reliability of its products. Nevertheless, semiconductor devices in general can malfunction or fail due to their inherent electrical sensitivity and vulnerability to physical stress. It is the responsibility of the buyer, when utilizing TOSHIBA products, to observe standards of safety, and to avoid situations in which a malfunction or failure of a TOSHIBA product could cause loss of human life, bodily injury or damage to property. In developing your designs, please ensure that TOSHIBA products are used within specified operating ranges as set forth in the most recent products specifications. Also, please keep in mind the precautions and conditions set forth in the TOSHIBA Semiconductor Reliability Handbook.

y PARAMETERS (Typ.) (COMMON EMITTER $V_{CE} = 6V$, $I_E = -1mA$, $f = 1MHz$)

CHARACTERISTIC	SYMBOL	2SC941-R	2SC941-O	2SC941-Y	UNIT
Input Conductance	g_{ie}	0.5	0.35	0.22	mS
Input Capacitance	C_{ie}	50	48	46	pF
Output Conductance	g_{oe}	4	5	6.5	μS
Output Capacitance	C_{oe}	3.7	3.4	3.2	pF
Forward Transfer Admittance	$ y_{fe} $	36	36	36	mS
Phase Angle of Forward Transfer Admittance	θ_{fe}	-1.6	-1.6	-1.6	°
Reverse Transfer Admittance	$ y_{re} $	14	14	14	μS
Phase Angle of Reverse Transfer Admittance	θ_{re}	-90	-90	-90	°

961001EAA2'

- The information contained herein is presented only as a guide for the applications of our products. No responsibility is assumed by TOSHIBA CORPORATION for any infringements of intellectual property or other rights of the third parties which may result from its use. No license is granted by implication or otherwise under any intellectual property or other rights of TOSHIBA CORPORATION or others.
- The information contained herein is subject to change without notice.

STATIC CHARACTERISTICS

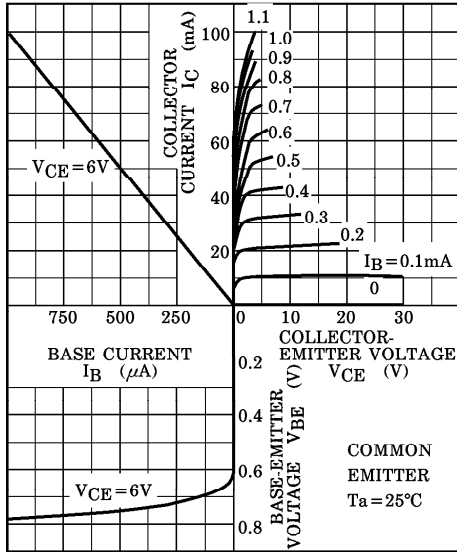

$h_{FE} - I_C$

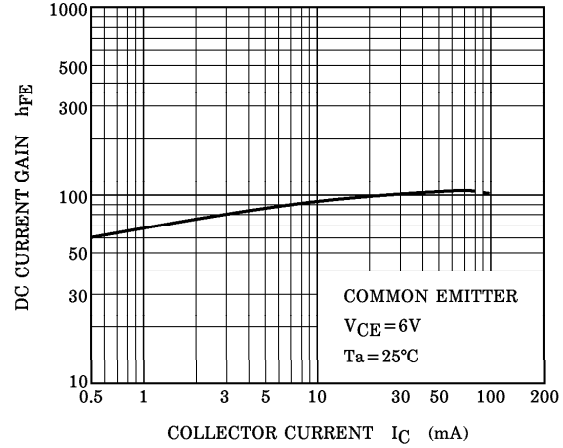

$f_T - I_C$

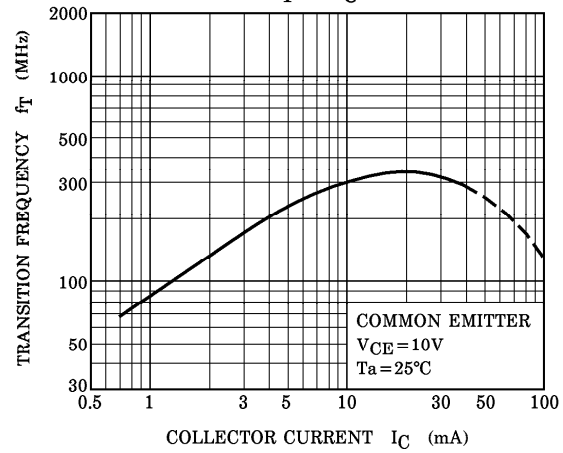

$g_{ie}, C_{ie} - I_E$

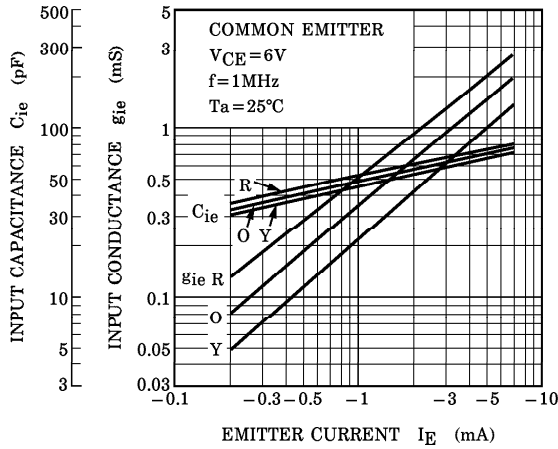

$|Y_{re}| - I_E$

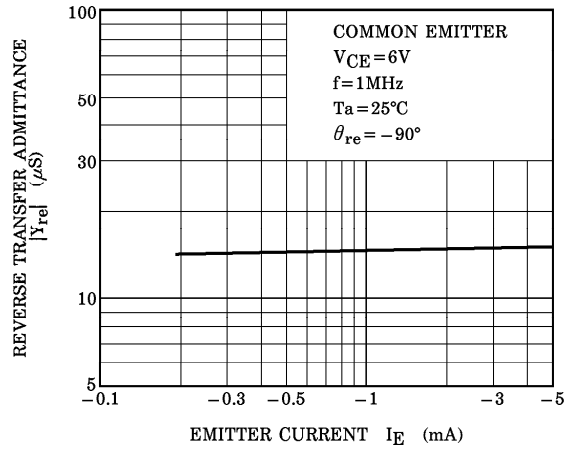

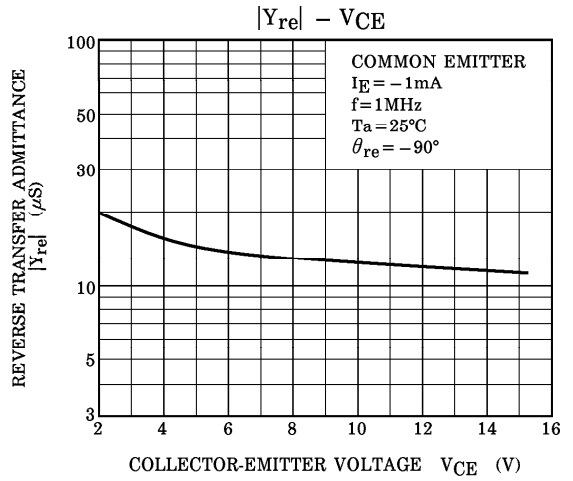
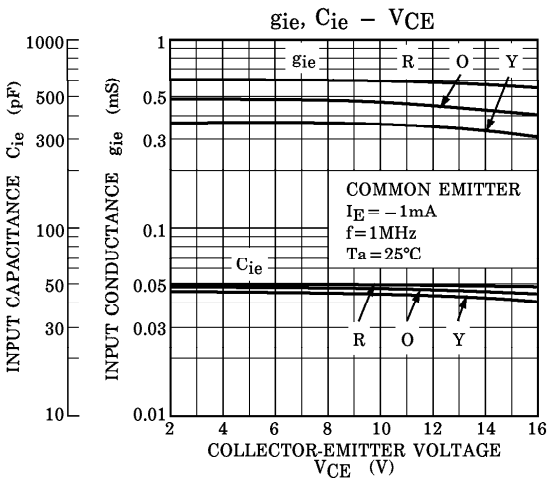
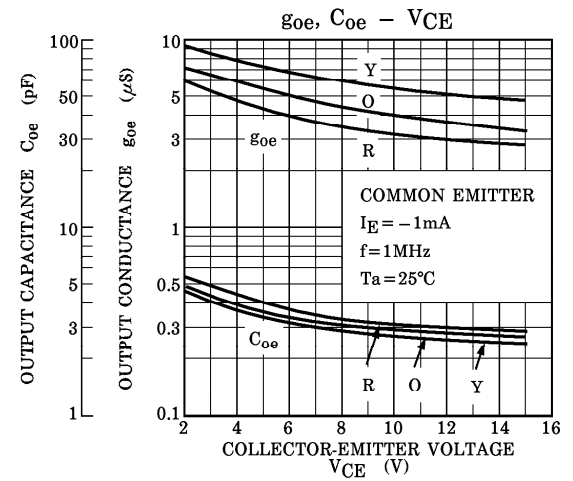
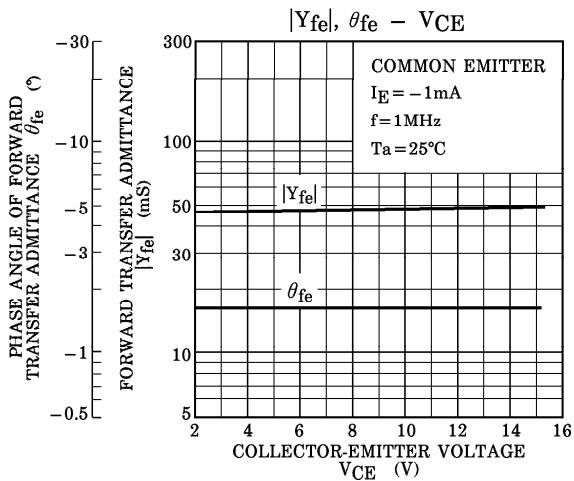
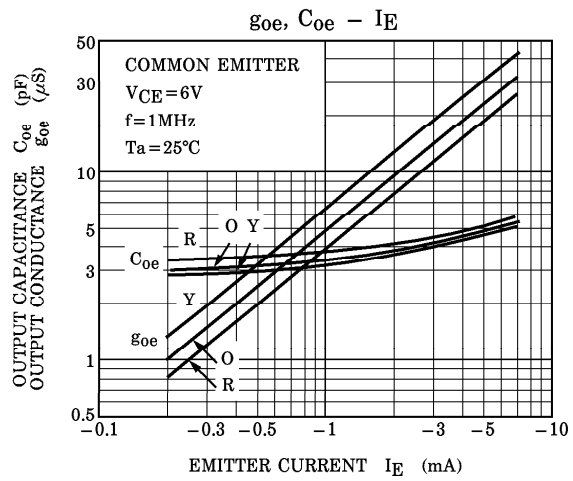
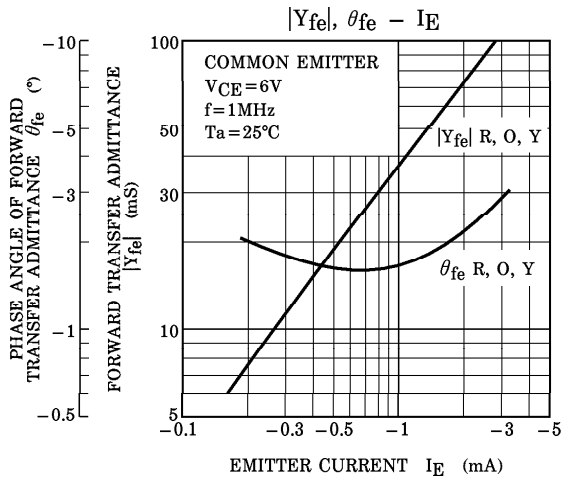

This datasheet has been downloaded from:

www.DatasheetCatalog.com

Datasheets for electronic components.