



2SC4242

NPN SILICON TRANSISTOR

SWITCHMODE SERIES NPN POWER TRANSISTORS

DESCRIPTION

The UTC 2SC4242 is a high-voltage, high-speed switching power transistor and designed particularly for 115 and 220V switch mode applications, such as switching regulators, inverters, DC-DC converter and general purpose power amplifiers.

FEATURES

- * Low saturation voltage.
- * Switching time: $t_f=0.5 \mu s$ (Max.)@ $I_c=5.0A$
- * High reliability

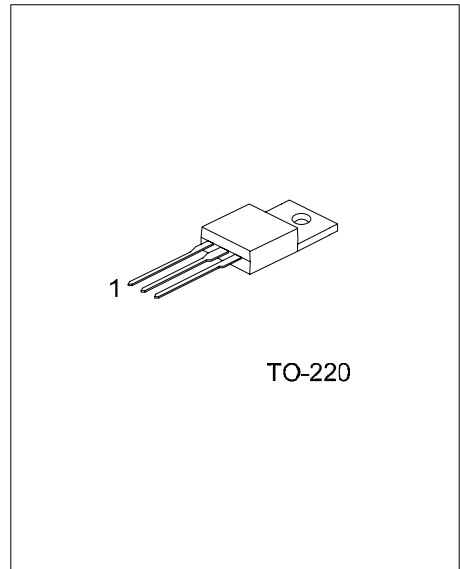

*Pb-free plating product number: 2SC4242L

ORDERING INFORMATION

Ordering Number		Package	Pin Assignment			Packing
Normal	Lead Free Plating		1	2	3	
2SC4242-TA3-T	2SC4242L-TA3-T	TO-220	B	C	E	Tube

<p>2SC4242L-TA3-T</p> <p>(1)Packing Type</p> <p>(2)Package Type</p> <p>(3)Lead Plating</p>	<p>(1) T: Tube</p> <p>(2) TA3: TO-220</p> <p>(3) L: Lead Free Plating, Blank: Pb/Sn</p>
--	---

■ ABSOLUTE MAXIMUM RATINGS

PARAMETER		SYMBOL	RATINGS	UNIT
Collector-Emitter Voltage		V_{CEO}	400	V
Collector-Base Voltage		V_{CBO}	450	V
Emitter-Base Voltage		V_{EBO}	8.0	V
Collector Current	Continuous	I_C	7.0	A
	Peak	I_{CM}	14	
Base Current		I_B	2.0	A
Total Power Dissipation @ $T_C=25$		P_D	40	W
Derate Above 25			0.32	W/°C
Junction Temperature		T_J	+150	°C
Storage Temperature		T_{STG}	-40 ~ +150	°C

Note: Absolute maximum ratings are those values beyond which the device could be permanently damaged. Absolute maximum ratings are stress ratings only and functional device operation is not implied.

■ THERMAL DATA

PARAMETER	SYMBOL	RATINGS	UNIT
Thermal Resistance Junction -Case	JC	4	°C/W

■ ELECTRICAL CHARACTERISTICS ($T_C=25^\circ\text{C}$, unless otherwise specified)

PARAMETER	SYMBOL	TEST CONDITIONS	MIN	TYP	MAX	UNIT
OFF CHARACTERISTICS						
Collector-Emitter Sustaining Voltage	BV_{CEO}	$I_{CEO}=100\text{mA}$, $I_B=0$	400			V
Collector-Base Breakdown Voltage	BV_{CBO}	$I_{CBO}=1.0\text{mA}$, $I_E=0$	450			V
Emitter-Base Breakdown Voltage	BV_{EBO}	$I_{EBO}=1.0\text{mA}$, $I_C=0$	8.0			V
Collector Cutoff Current	I_{CBO}	$V_{CBO}=450\text{V}$, $I_E=0$			100	μA
Emitter Cutoff Current	I_{EBO}	$V_{EBO}=8.0\text{V}$, $I_C=0$			100	μA
ON CHARACTERISTICS						
DC Current Gain	h_{FE}	$I_C=4.0\text{A}$, $V_{CE}=5.0\text{V}$	10			
Collector-Emitter Saturation Voltage	$V_{CE(SAT)}$	$I_C=4.0\text{A}$, $I_B=800\text{mA}$			0.8	V
Base-Emitter Saturation Voltage	$V_{BE(SAT)}$	$I_C=4.0\text{A}$, $I_B=800\text{mA}$			1.2	V
SWITCHING CHARACTERISTICS						
On Time	t_{ON}	$V_{CC}=150\text{V}$, $I_C=5.0\text{A}$ $I_{B1} = -I_{B2}=1.0\text{A}$, $R_L=30$			1.0	μs
Storage Time	t_S				2.5	μs
Fall Time	t_F				0.5	μs

Note: Pulse Test: Pulse Width=300 μs , Duty Cycle \leq 2.0%

TYPICAL CHARACTERISTIC

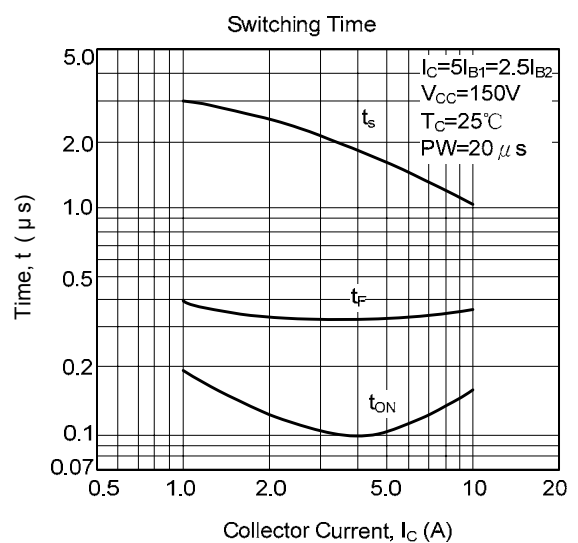
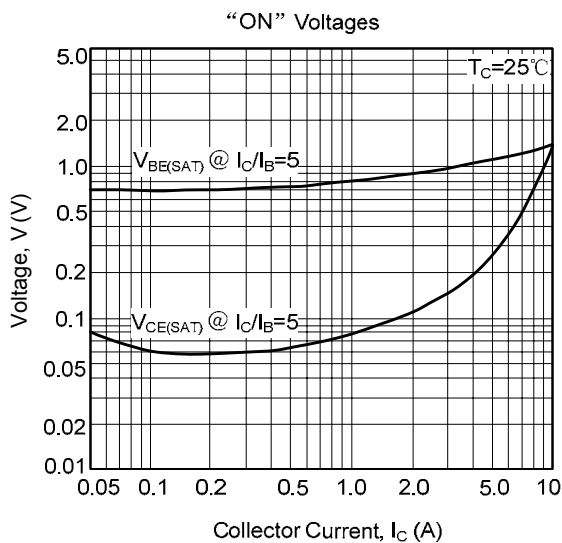
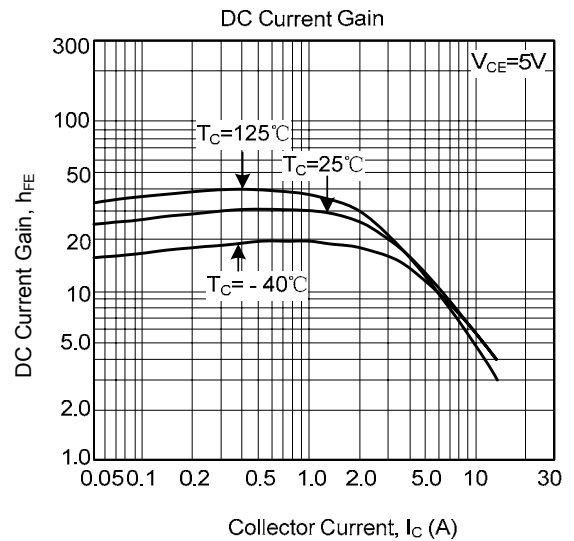
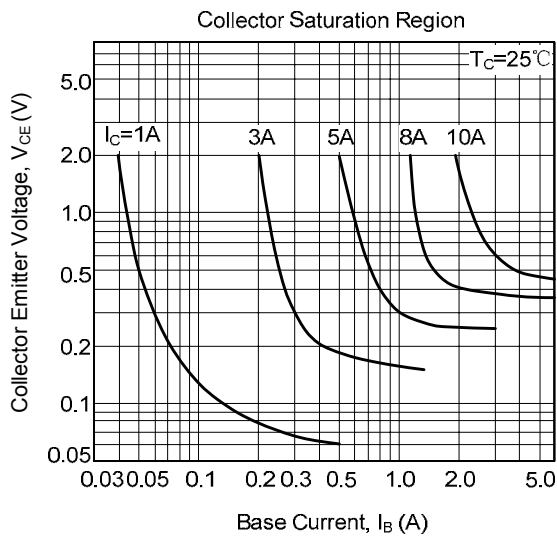
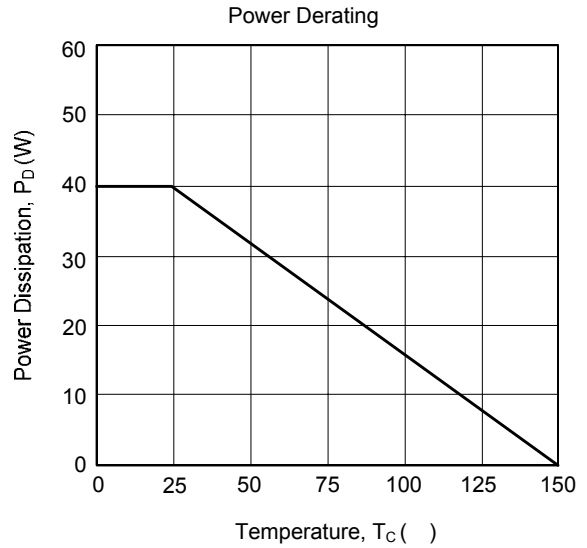
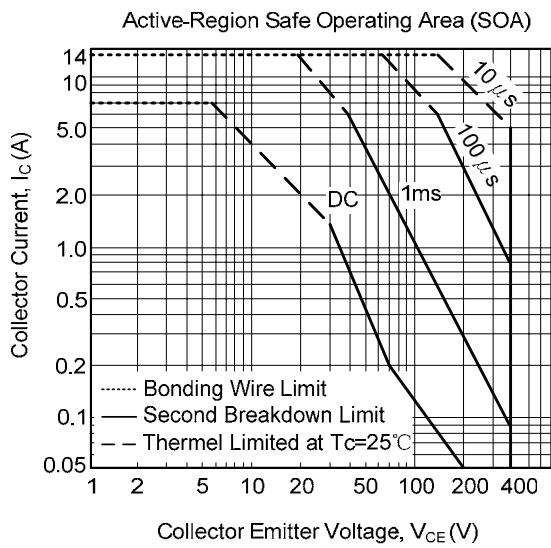

UTC assumes no responsibility for equipment failures that result from using products at values that exceed, even momentarily, rated values (such as maximum ratings, operating condition ranges, or other parameters) listed in products specifications of any and all UTC products described or contained herein. UTC products are not designed for use in life support appliances, devices or systems where malfunction of these products can be reasonably expected to result in personal injury. Reproduction in whole or in part is prohibited without the prior written consent of the copyright owner. The information presented in this document does not form part of any quotation or contract, is believed to be accurate and reliable and may be changed without notice.