

SILICON NPN TRIPLE DIFFUSED TYPE (PCT PROCESS)

2SC1569

Unit in mm

COLOR TV CHROMA OUTPUT APPLICATIONS.

FEATURES:

- High Voltage : $V_{CEO}=300V$
- Small Collector Output Capacitance : $C_{ob}=5.0pF(Typ.)$
- High Transition Frequency : $f_T=100MHz (Typ.)$

MAXIMUM RATINGS (Ta=25°C)

CHARACTERISTIC		SYMBOL	RATING	UNIT
Collector-Base Voltage		V_{CBO}	300	V
Collector-Emitter Voltage		V_{CEO}	300	V
Emitter-Base Voltage		V_{EBO}	5	V
Collector Current		I_C	150	mA
Emitter Current		I_E	-150	mA
Collector Power Dissipation	Ta=25°C	P_C	1.5	W
	Tc=25°C		12.5	
Junction Temperature		T_j	150	°C
Storage Temperature Range		T_{stg}	-55~150	°C

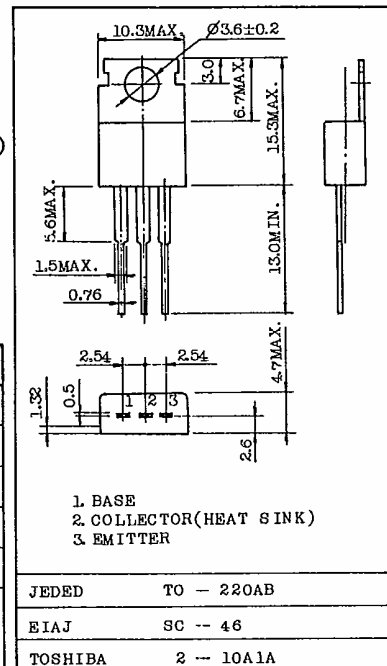

Mounting kit No. AC75
Weight : 1.9g

ELECTRICAL CHARACTERISTICS (Ta=25°C)

CHARACTERISTIC	SYMBOL	TEST CONDITION	MIN.	TYP.	MAX.	UNIT
Collector Cut-off Current	I_{CBO}	$V_{CB}=100V, I_E=0$	-	-	1.0	μA
Emitter Cut-off Current	I_{EBO}	$V_{EB}=5V, I_C=0$	-	-	1.0	μA
Collector-Emitter Breakdown Voltage	$V_{(BR)CEO}$	$I_C=5mA, I_B=0$	300	-	-	V
DC Current Gain	h_{FE}	$V_{CE}=10V, I_C=50mA$	40	-	170	
Collector-Emitter Saturation Voltage	$V_{CE(sat)}$	$I_C=100mA, I_B=20mA$	-	-	1.0	V
Base-Emitter Saturation Voltage	$V_{BE(sat)}$	$I_C=100mA, I_B=20mA$	-	-	1.2	V
Transition Frequency	f_T	$V_{CE}=10V, I_C=30mA$	40	100	-	MHz
Collector Output Capacitance	C_{ob}	$V_{CB}=50V, I_E=0, f=1MHz$	-	5.0	6.5	pF

..... TOSHIBA CORPORATION

2SC1569

STATIC CHARACTERISTICS

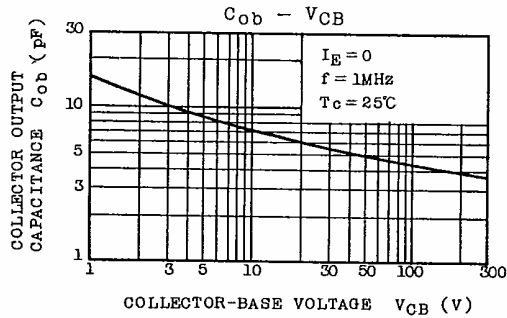
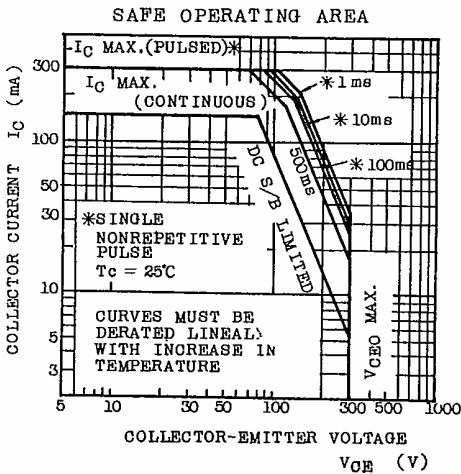
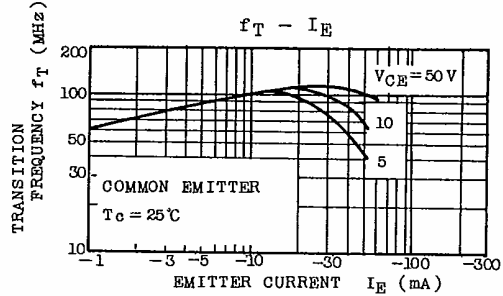
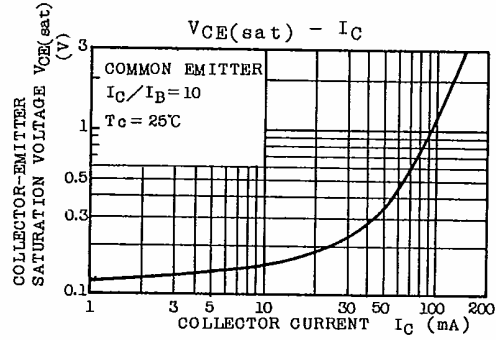
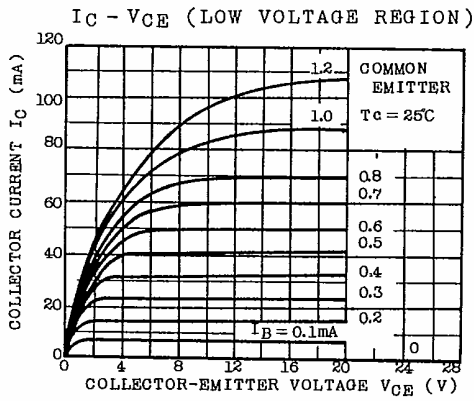
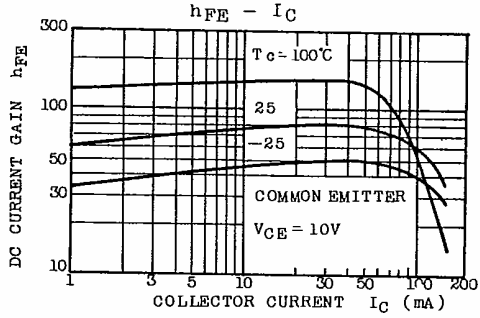
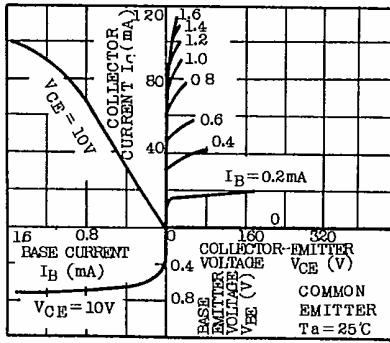

TOSHIBA CORPORATION