



■ Features :

- Universal AC input / Full range (up to 305VAC)
- Protections: Short circuit / Overload / Over voltage / Over temperature
- Built-in active PFC function
- Cooling by free air convection
- Fully isolated plastic case
- Class II power unit, no FG
- Class 2 power unit
- IP67(optional , model NO. : LPF-16-12P)
- Suitable for LED lighting and moving sign applications
- Compliance to worldwide safety regulations for lighting
- Suitable for dry / damp locations(wet location for LPF-16-12P)
- 3 years warranty



SPECIFICATION



MODEL		LPF-16-12	LPF-16-15	LPF-16-20	LPF-16-24	LPF-16-30	LPF-16-36	LPF-16-42	LPF-16-48	LPF-16-54	
OUTPUT	DC VOLTAGE	12V	15V	20V	24V	30V	36V	42V	48V	54V	
	CONSTANT CURRENT REGION Note.4	6 ~12V	7.5 ~ 15V	10 ~ 20V	12 ~ 24V	15 ~ 30V	18 ~ 36V	21 ~ 42V	24 ~ 48V	27 ~ 54V	
	RATED CURRENT	1.34A	1.07A	0.8A	0.67A	0.54A	0.45A	0.39A	0.34A	0.3A	
	RATED POWER	16.08W	16.05W	16W	16.08W	16.2W	16.2W	16.38W	16.32W	16.2W	
	RIPPLE & NOISE (max.) Note.2	150mVp-p	150mVp-p	150mVp-p	150mVp-p	200mVp-p	250mVp-p	250mVp-p	250mVp-p	350mVp-p	
	VOLTAGE TOLERANCE Note.3	±4.0%	±4.0%	±4.0%	±4.0%	±4.0%	±4.0%	±4.0%	±4.0%	±4.0%	
	LINE REGULATION	±0.5%	±0.5%	±0.5%	±0.5%	±0.5%	±0.5%	±0.5%	±0.5%	±0.5%	
	LOAD REGULATION	±2.0%	±1.5%	±1.0%	±0.5%	±0.5%	±0.5%	±0.5%	±0.5%	±0.5%	
	SETUP, RISE TIME Note.6	1500ms, 80ms / 115VAC at full load 1500ms, 80ms / 230VAC									
HOLD UP TIME (Typ.)	16ms at full load 230VAC /115VAC										
INPUT	VOLTAGE RANGE Note.5	90 ~ 305VAC		127 ~ 431VDC							
	FREQUENCY RANGE	47 ~ 63Hz									
	POWER FACTOR (Typ.)	PF>0.97/115VAC, PF>0.95/230VAC, PF>0.92/277VAC at full load (Please refer to "Power Factor Characteristic" curve)									
	EFFICIENCY (Typ.)	84%	84%	86%	86%	86%	86%	86%	86%	86%	
	AC CURRENT	0.4A / 115VAC		0.2A / 230VAC							
	INRUSH CURRENT (Typ.)	COLD START 50A/230VAC									
	LEAKAGE CURRENT	<0.75mA / 240VAC									
PROTECTION	OVER CURRENT Note.4	95 ~ 108% Protection type : Constant current limiting, recovers automatically after fault condition is removed									
	SHORT CIRCUIT	Hiccup mode, recovers automatically after fault condition is removed.									
	OVER VOLTAGE	15 ~ 18V	17.5 ~ 21V	23 ~ 27V	28 ~ 35V	34 ~ 40V	41 ~ 49V	46 ~ 54V	54 ~ 63V	59 ~ 66V	
	OVER TEMPERATURE	100J 5J(TSW1) Detect on U2 Protection type : Shut down o/p voltage, recover automatically after temperature goes down									
ENVIRONMENT	WORKING TEMP.	-40 ~ +70°C (Refer to "Derating Curve")									
	WORKING HUMIDITY	20 ~ 95% RH non-condensing									
	STORAGE TEMP., HUMIDITY	-40 ~ +80°C, 10 ~ 95% RH									
	TEMP. COEFFICIENT	±0.03%/°C (0 ~ 50°C)									
	VIBRATION	10 ~ 500Hz, 2G 12min./1cycle, period for 72min. each along X, Y, Z axes									
SAFETY & EMC	SAFETY STANDARDS	UL8750, CSAC22.2 No. 250.0-08 (except for 48V, 54V),EN61347-1, EN61347-2-13 independent approved, IP67 (optional) ; Design refer to UL60950-1, TUV EN60950-1									
	WITHSTAND VOLTAGE	I/P-O/P:3.75KVAC									
	ISOLATION RESISTANCE	I/P-O/P:100M Ohms / 500VDC / 25°C/ 70% RH									
	EMC EMISSION	Compliance to EN55015; EN61000-3-2 Class C (≥ 50% load) ; EN61000-3-3									
OTHERS	EMC IMMUNITY	Compliance to EN61000-4-2,3,4,5,6,8,11; EN61547,light industry level(surge 2KV), criteria A									
	MTBF	473.3Khrs min. MIL-HDBK-217F (25°C)									
	DIMENSION	148*40*32mm (L*W*H)									
	PACKING	0.21Kg; 40pcs/9.4Kg/1.02CUFT									
NOTE	<ol style="list-style-type: none"> 1. All parameters NOT specially mentioned are measured at 230VAC input, rated load and 25°C of ambient temperature. 2. Ripple & noise are measured at 20MHz of bandwidth by using a 12" twisted pair-wire terminated with a 0.1uf & 47uf parallel capacitor. 3. Tolerance : includes set up tolerance, line regulation and load regulation. 4. Constant current operation region is within 50% ~100% rated output voltage. This is the suitable operation region for LED related applications, but please reconfirm special electrical requirements for some specific system design. 5. Derating may be needed under low input voltages. Please check the static characteristics for more details. 6. Length of set up time is measured at cold first start. Turning ON/OFF the power supply may lead to increase of the set up time. 7. The power supply is considered as a component that will be operated in combination with final equipment. Since EMC performance will be affected by the complete installation, the final equipment manufacturers must re-qualify EMC Directive on the complete installation again. 										

■ Mechanical Specification

Case No. : LPF-16A Unit:mm

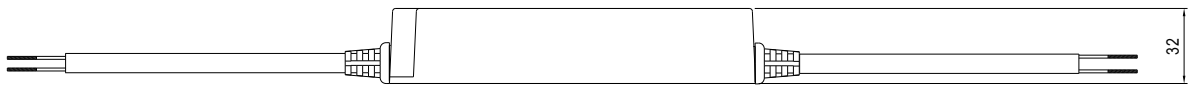
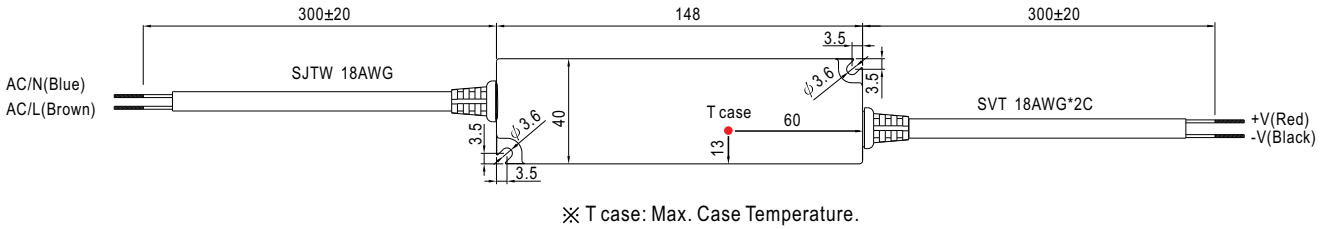

■ Block Diagram

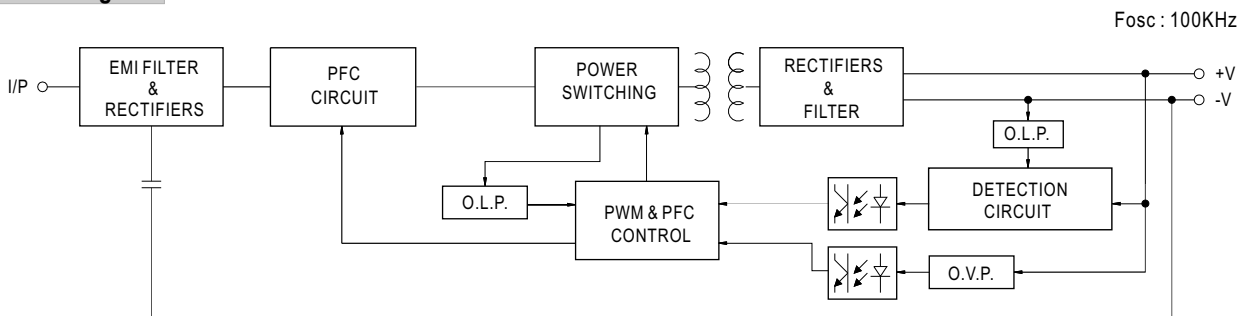

■ Derating Curve

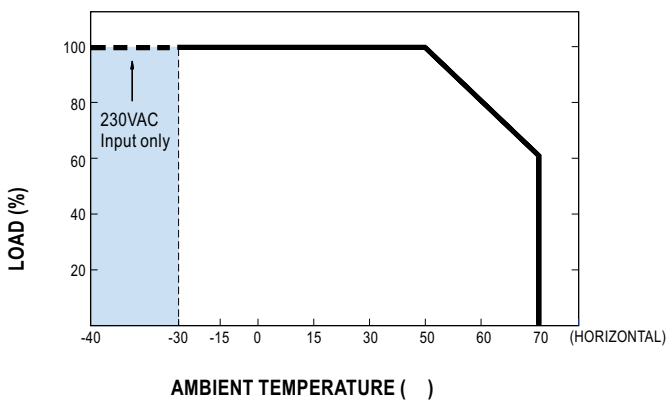

■ Static Characteristics

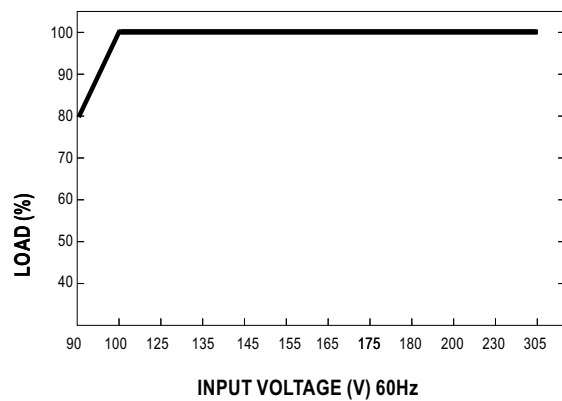

Power Factor Characteristic

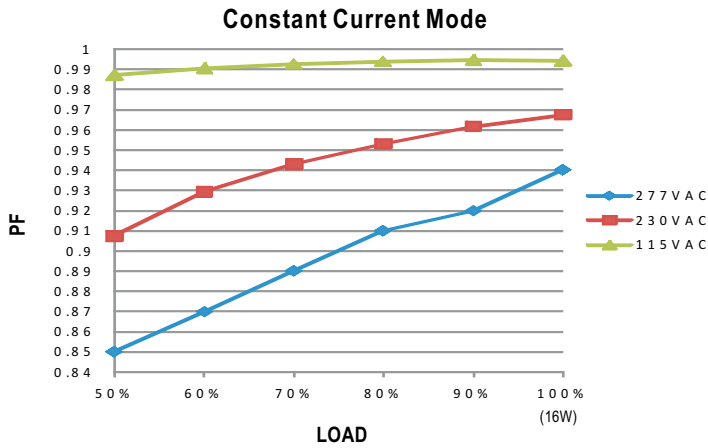

EFFICIENCY vs LOAD (48V Model)

LPF-16 series possess superior working efficiency that up to 86% can be reached in field applications.

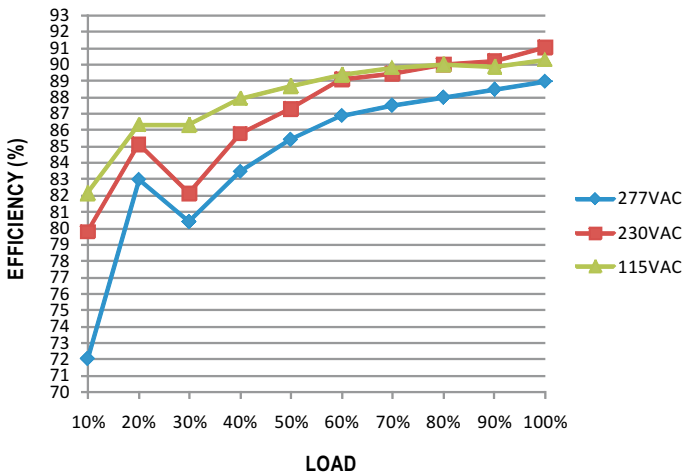

DRIVING METHODS OF LED MODULE

There are two major kinds of LED drive method "direct drive" and "with LED driver".

A typical LED power supply may either work in "constant voltage mode (CV) or constant current mode (CC)" to drive the LEDs.

Mean Well's LED power supply with CV+ CC characteristic can be operated at both CV mode (with LED driver, at area (A) and CC mode (direct drive, at area (B).

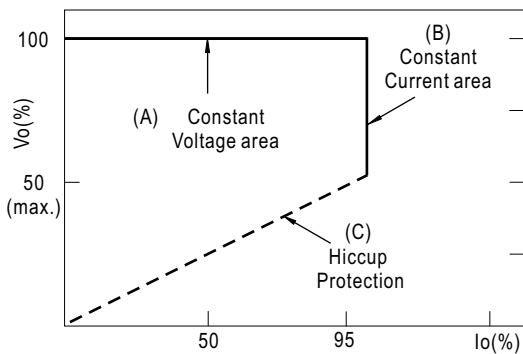

Typical LED power supply I-V curve