

# PC852 Series PC853/PC853H

## High Collector-emitter Voltage Type Photocouplers

\* Lead forming type (I type) and taping reel type (P type) are also available. (PC852I/PC852P/PC853I/PC853P)

### ■ Features

- High collector-emitter voltage  
**PC852 Series, PC853** ( $V_{CEO} : 300V$ )  
**PC853H** ( $V_{CEO} : 350V$ )
- High current transfer ratio  
(CTR: MIN. 1 000% at  $I_F = 1mA, V_{CE} = 2V$ )
- High isolation voltage between input and output ( $V_{iso} : 5\ 000V_{rms}$ )
- Compact dual-in-line package  
**PC852, PC853, PC853H** (1-channel type)

**PC8D52** (2-channel type)

**PC8Q52** (4-channel type)

- Large collector power dissipation.  
**PC853, PC853H** ( $P_c : 300mW$ )
- Recognized by UL (NO. E64380)

### ■ Applications

- Telephone sets
- Copiers, facsimiles
- Interface with various power supply circuits, power distribution boards
- Numerical control machines

(Unit : mm)

### ■ Outline Dimensions

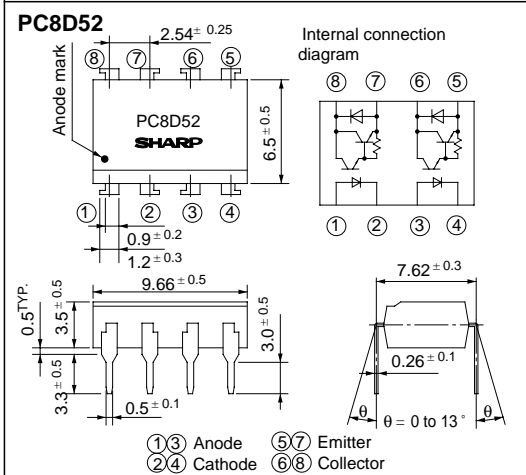
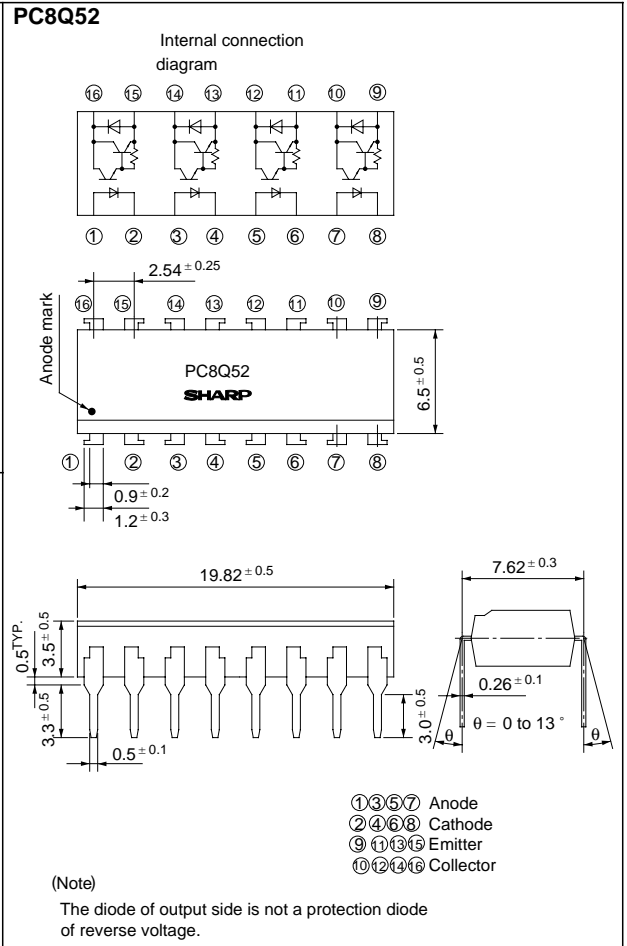
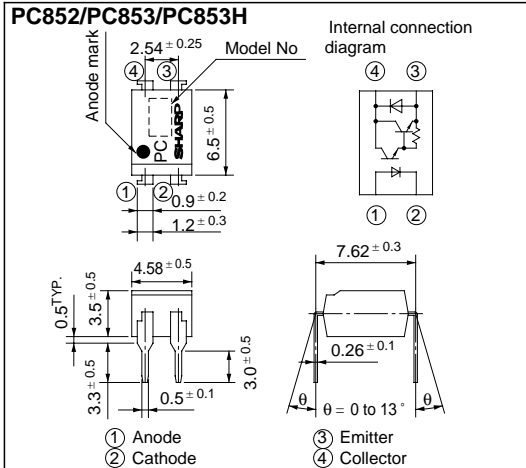

## Absolute Maximum Ratings

(Ta = 25°C)

Parameter	Symbol	Rating			Unit
		PC852 Series	PC853	PC853H	
Input	Forward current	I <sub>F</sub>	50	50	mA
	*1 Peak forward current	I <sub>FM</sub>	1	1	A
	Reverse voltage	V <sub>R</sub>	6	6	V
	Power dissipation	P	70	70	mW
Output	Collector-emitter voltage	V <sub>CEO</sub>	300	300   350	V
	Emitter-collector voltage	V <sub>ECO</sub>	0.1	0.1	V
	Collector current	I <sub>C</sub>	150	150	mA
	Collector power dissipation	P <sub>C</sub>	150	300	mW
	Total power dissipation	P <sub>tot</sub>	200	320	mW
*2 Isolation voltage	V <sub>iso</sub>	5 000	5 000	V <sub>rms</sub>	
Operating temperature	T <sub>opr</sub>	- 30 to + 100	- 30 to + 100	°C	
Storage temperature	T <sub>stg</sub>	- 55 to + 125	- 55 to + 125	°C	
*3 Soldering temperature	T <sub>sol</sub>	260	260	°C	

\*1 Pulse width ≤ 100μs, Duty ratio : 0.001

\*2 40 to 60% RH, AC for 1 minute

\*3 For 10 seconds

## Electro-optical Characteristics

(Ta = 25°C)

Parameter		Symbol	Conditions	MIN.	TYP.	MAX.	Unit	
Input	Forward voltage	V <sub>F</sub>	I <sub>F</sub> = 10mA	-	1.2	1.4	V	
	Reverse current	I <sub>R</sub>	V <sub>R</sub> = 4V	-	-	10	μA	
	Terminal capacitance	C <sub>t</sub>	V = 0, f = 1kHz	-	30	250	pF	
Output	Collector dark current	I <sub>CEO</sub>	V <sub>CE</sub> = 200V, I <sub>F</sub> = 0	-	-	2 x 10 <sup>-7</sup>	A	
Transfer characteristics	Current transfer ratio	CTR	I <sub>F</sub> = 1mA, V <sub>CE</sub> = 2V	1 000	4 000	15 000	%	
	Collector-emitter saturation voltage	V <sub>CE(sat)</sub>	I <sub>F</sub> = 20mA, I <sub>C</sub> = 100mA	-	-	1.2	V	
	Isolation resistance	R <sub>ISO</sub>	DC500V, 40 to 60% RH	5 x 10 <sup>10</sup>	10 <sup>11</sup>	-	Ω	
	Floating capacitance	C <sub>f</sub>	V = 0, f = 1MHz	-	0.6	1.0	pF	
	Cut-off frequency	f <sub>c</sub>	V <sub>CE</sub> = 2V, I <sub>C</sub> = 20mA, R <sub>L</sub> = 100Ω, - 3dB	1	7	-	kHz	
	Response time	Rise time	t <sub>r</sub>	V <sub>CE</sub> = 2V, I <sub>C</sub> = 20mA	-	100	300	μs
		Fall time	t <sub>f</sub>	R <sub>L</sub> = 100Ω	-	20	100	μs

**Fig. 1 Forward Current vs. Ambient Temperature**

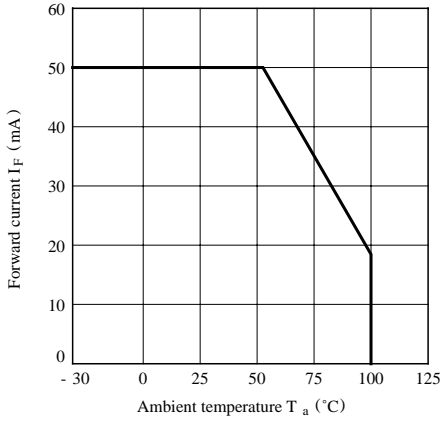

**Fig. 2-a Collector Power Dissipation vs. Ambient Temperature (PC852 Series)**

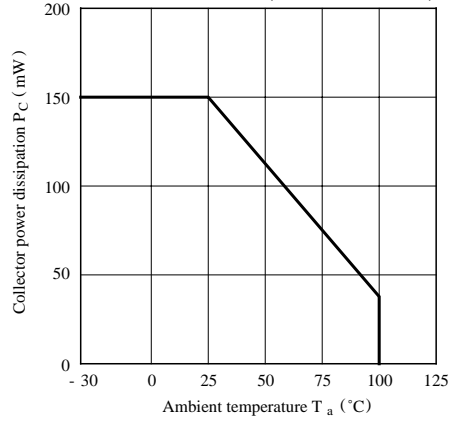

**Fig. 2-b Collector Power Dissipation vs. Ambient Temperature (PC853/PC853H)**

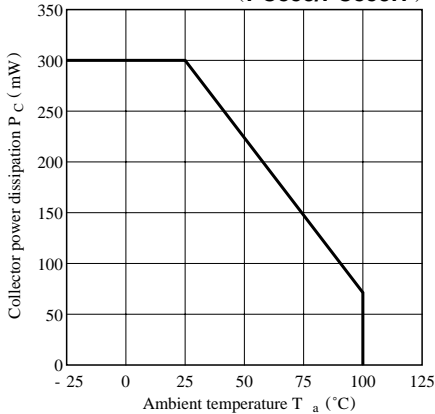

**Fig. 3 Peak Forward Current vs. Duty Ratio**

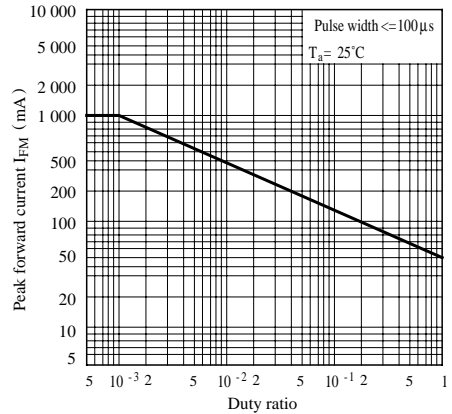

**Fig. 4 Forward Current vs. Forward Voltage**

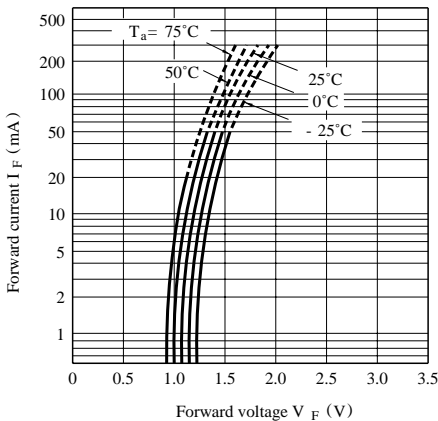

**Fig. 5-a Current Transfer Ratio vs. Forward Current (PC852 Series)**

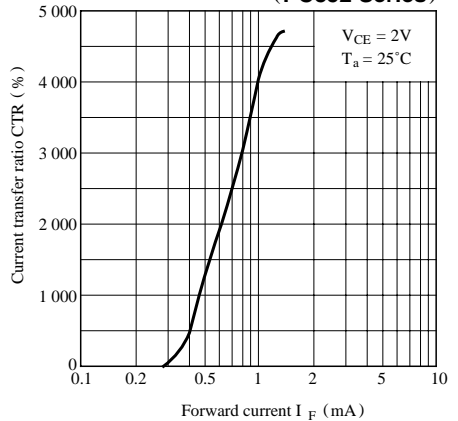

**Fig. 5-b Current Transfer Ratio vs. Forward Current**

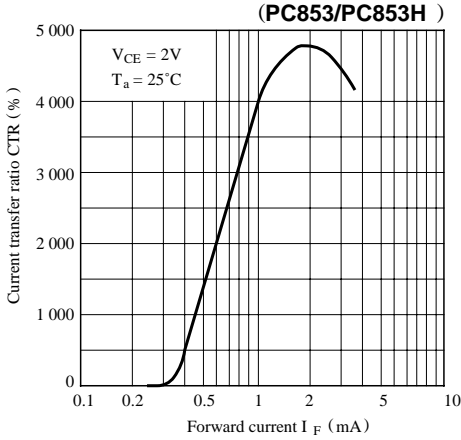

**Fig. 6-a Collector Current vs. Collector-emitter Voltage**  
(PC852 Series)

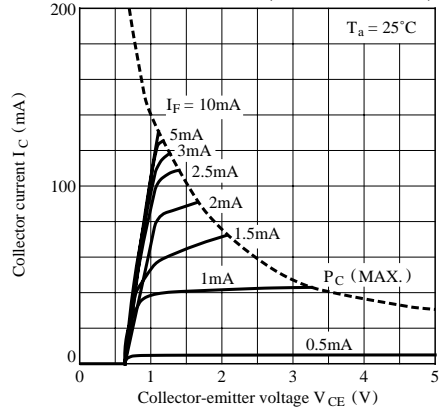

**Fig. 6-b Collector Current vs. Collector-emitter Voltage**  
(PC853 / PC853H)

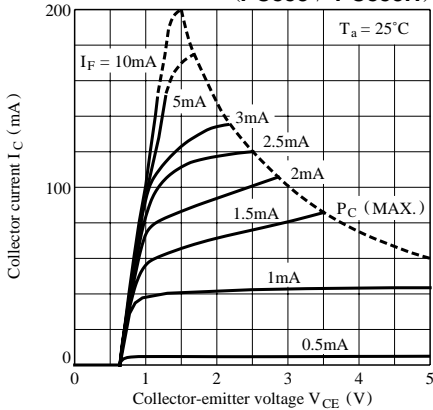

**Fig. 7 Relative Current Transfer Ratio vs. Ambient Temperature**

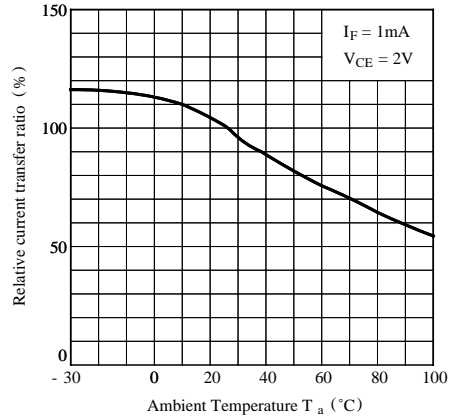

**Fig. 8 Collector-emitter Saturation Voltage vs. Ambient Temperature**

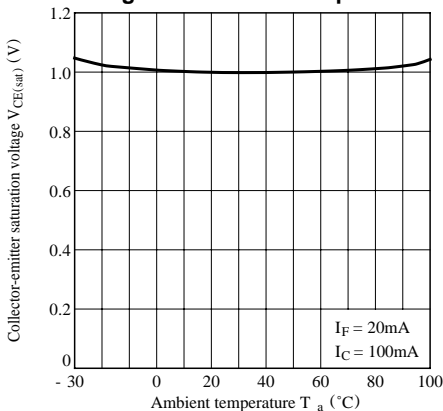

**Fig. 9 Collector Dark Current vs. Ambient Temperature**

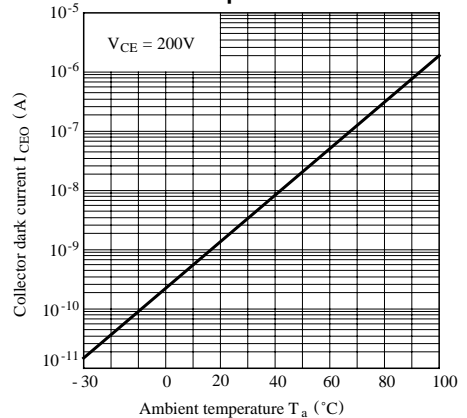

**Fig.10 Response Time vs. Load Resistance**

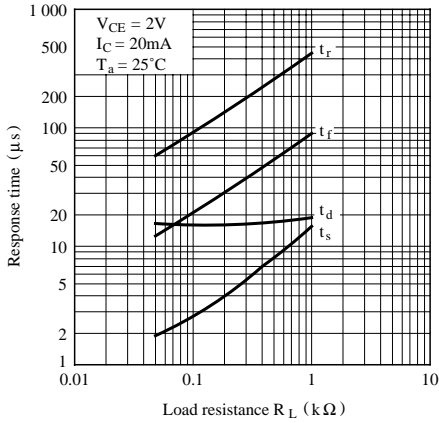

**Fig.11 Frequency Response**

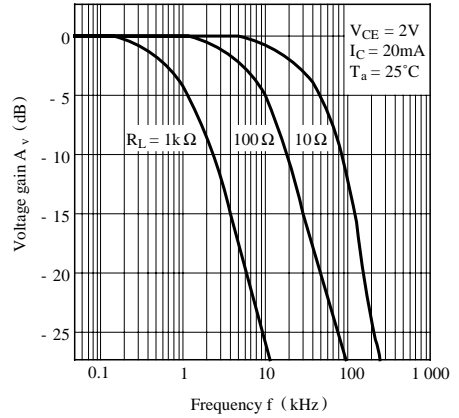

**Fig.12 Collector-emitter Saturation Voltage vs. Forward Current**

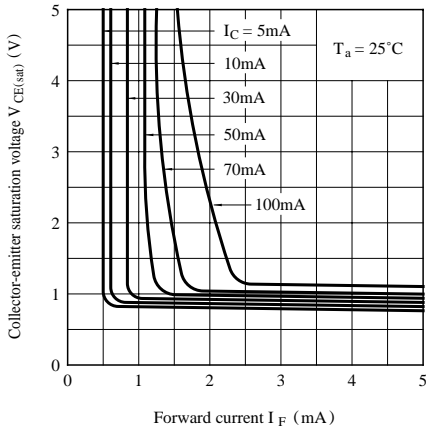

● Please refer to the chapter “Precautions for Use”