

**7-UNIT 150mA SOURCE TYPE DARLINGTON TRANSISTOR ARRAY**

6249826 MITSUBISHI ELEK (LINEAR)

80C 09313 D T-43-25

**DESCRIPTION**

The M54560P, 7-channel source driver, consists of 7 PNP and 7 NPN transistors, connected to form high current gain driver with PNP action.

**FEATURES**

- High output sustaining voltage to 40V
- Output source current to 150mA
- Integral diode for transient suppression
- Active "L" input
- Wide operating temperature range ( $T_a = -20 \sim +75^\circ\text{C}$ )

**APPLICATION**

Relay and printer driver, LED, incandescent or fluorescent display driver, Interfacing for standard MOS/BIPO-LAR logics

**FUNCTION**

The M54560P is comprised of seven PNP-NPN darlington source driver pairs with  $20k\Omega$  series input resistors. Each output has an integral diode for inductive load transient suppression. The anodes of the diodes and the substrate connected together to pin 9. The outputs are capable of driving 150mA and are rated for operation with output voltages of up to 40V. The output is turned ON by switching the input low.

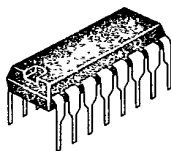

16-pin molded plastic DIP

**PIN CONFIGURATION (TOP VIEW)**

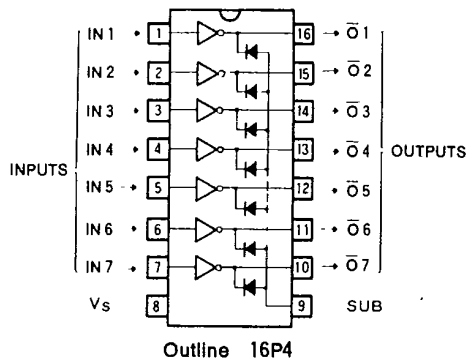

**CIRCUIT SCHEMATIC**

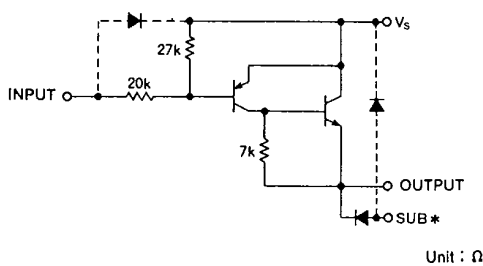

**ABSOLUTE MAXIMUM RATINGS** ( $T_a = -20 \sim +75^\circ\text{C}$ , unless otherwise noted)

Symbol	Parameter	Conditions	Ratings	Unit
$V_{CEO}$	Output sustaining voltage	Output is in "L"	-0.5~+40	V
$V_s$	Supply voltage		40	V
$V_i$	Input voltage		0~+40	V
$I_o$	Output current	Per channel current at "H" output	-150	mA
$I_F$	Clamp diode forward current		-150	mA
$V_R$	Clamp diode reverse voltage		40	V
$P_d$	Power dissipation	$T_a = 25^\circ\text{C}$	1.47	W
$T_{opr}$	Operating ambient temperature range		-20~+75	$^\circ\text{C}$
$T_{stg}$	Storage temperature range		-55~+125	$^\circ\text{C}$

**7-UNIT 150mA SOURCE TYPE DARLINGTON TRANSISTOR ARRAY**

**RECOMMENDED OPERATIONAL CONDITIONS** ( $T_a = -20 \sim +75^\circ\text{C}$ , unless otherwise noted)

Symbol	Parameter	Limits			Unit
		Min	Typ	Max	
$V_S$	Supply voltage	0		40	V
$I_O$	Output current per channel	Percent duty cycle less than 90%	0	-100	mA
		Percent duty cycle less than 100%	0	-50	
$V_{IH}$	"H" Input voltage	$V_S - 0.2$		$V_S + 0.3$	V
$V_{IL}$	"L" Input voltage	$I_O = -100\text{mA}$	0	$V_S - 5$	V
		$I_O = -50\text{mA}$	0	$V_S - 3.5$	

**ELECTRICAL CHARACTERISTICS** ( $T_a = -20 \sim +75^\circ\text{C}$ , unless otherwise noted)

Symbol	Parameter	Test conditions	Limits			Unit
			Min	Typ	Max	
$I_{S(\text{leak})}$	Supply leakage current	$V_S = 40\text{V}$			100	$\mu\text{A}$
$V_{CE(\text{sat})}$	Output saturation voltage	$V_I = V_S - 5\text{V}, I_O = -100\text{mA}$		0.82	1.5	V
		$V_I = V_S - 3.5\text{V}, I_O = -50\text{mA}$		0.75	1.2	
$I_I$	Input voltage	$V_I = V_S - 8.5\text{V}$		-380	-670	$\mu\text{A}$
$V_F$	Clamp diode forward voltage	$I_F = -100\text{mA}$		-1.1	-2.4	V
$V_R$	Clamp diode reverse voltage	$I_R = 100\mu\text{A}$	40			V
$h_{FE}$	DC forward current gain	$V_S - V_O = 4\text{V}, I_O = -100\text{mA}, T_a = 25^\circ\text{C}$	500	2800		-

**TYPICAL CHARACTERISTICS**

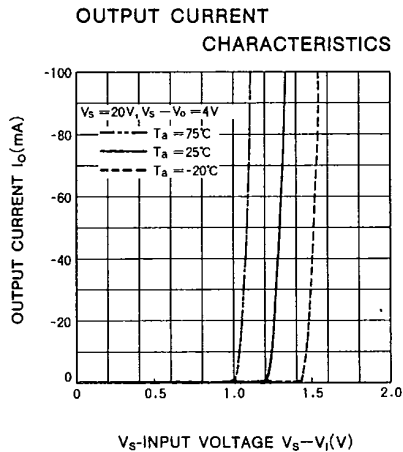
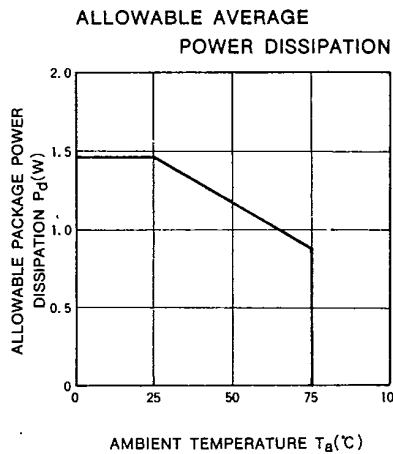

**7-UNIT 150mA SOURCE TYPE DARLINGTON TRANSISTOR ARRAY**

**ALLOWABLE OUTPUT CURRENT AS A FUNCTION OF DUTY CYCLE**

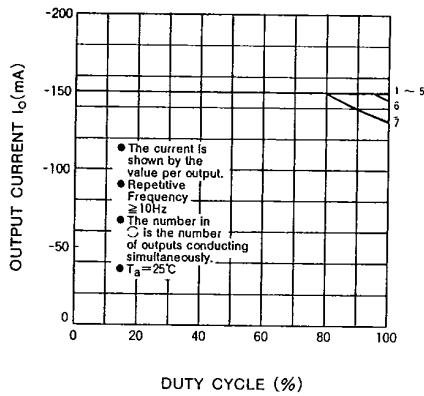

**ALLOWABLE OUTPUT CURRENT AS A FUNCTION OF DUTY CYCLE**

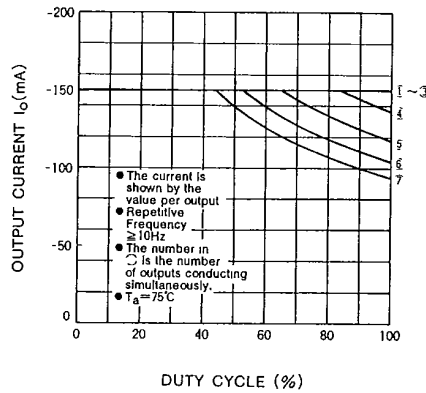

**DC CURRENT GAIN CHARACTERISTICS**

