

LM6165/LM6265/LM6365 High Speed Operational Amplifier

General Description

The LM6165 family of high-speed amplifiers exhibits an excellent speed-power product in delivering 300 V/ μ s and 725 MHz GBW (stable for gains as low as +25) with only 5 mA of supply current. Further power savings and application convenience are possible by taking advantage of the wide dynamic range in operating supply voltage which extends all the way down to +5V.

These amplifiers are built with National's VIP™ (Vertically Integrated PNP) process which produces fast PNP transistors that are true complements to the already fast NPN devices. This advanced junction-isolated process delivers high speed performance without the need for complex and expensive dielectric isolation.

Features

- High slew rate: 300 V/ μ s

- High GBW product: 725 MHz
- Low supply current: 5 mA
- Fast settling: 80 ns to 0.1%
- Low differential gain: <0.1%
- Low differential phase: <0.1°
- Wide supply range: 4.75V to 32V
- Stable with unlimited capacitive load

Applications

- Video amplifier
- Wide-bandwidth signal conditioning
- Radar
- Sonar

Connection Diagrams

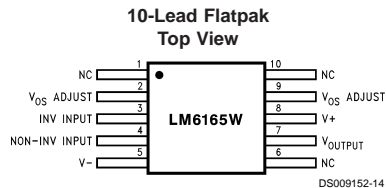

Order Number **LM6165W/883**
See NS Package Number **W10A**

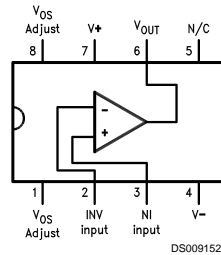

Order Number **LM6165J/883**
See NS Package Number **J08A**
Order Number **LM6365M**
See NS Package Number **M08A**
Order Number **LM6265N** or **LM6365N**
See NS Package Number **N08E**

Connection Diagrams (Continued)

| Temperature Range | | | Package | NSC Drawing |
|--|---|---|-----------------------------|-------------|
| Military $-55^{\circ}\text{C} \leq T_A \leq +125^{\circ}\text{C}$ | Industrial $-25^{\circ}\text{C} \leq T_A \leq +85^{\circ}\text{C}$ | Commercial $0^{\circ}\text{C} \leq T_A \leq +70^{\circ}\text{C}$ | | |
| | LM6265N | LM6365N | 8-Pin Molded DIP | N08E |
| LM6165J/883 5962-8962501PA | | | 8-Pin Ceramic DIP | J08A |
| | | LM6365M | 8-Pin Molded Surface Mt. | M08A |
| LM6165WG/883 5962-8962501XA | | | 10-Lead Ceramic SOIC | WG10A |
| LM6165W883 5962-8962501HA | | | 10-Pin Ceramic Flatpak | W10A |

Absolute Maximum Ratings (Note 1)

If Military/Aerospace specified devices are required, please contact the National Semiconductor Sales Office/Distributors for availability and specifications.

| | |
|---|----------------------------------|
| Supply Voltage ($V^+ - V^-$) | 36V |
| Differential Input Voltage (Note 7) | $\pm 8V$ |
| Common-Mode Voltage Range (Note 11) | $(V^+ - 0.7V)$ to $(V^- + 0.7V)$ |
| Output Short Circuit to GND (Note 2) | Continuous |
| Soldering Information | |
| Dual-In-Line Package (N, J) Soldering (10 sec.) | 260°C |
| Small Outline Package (M) Vapor Phase (60 sec.) | 215°C |
| Infrared (15 sec.) | 220°C |

See AN-450 "Surface Mounting Methods and Their Effect on Product Reliability" for other methods of soldering surface mount devices.

| | |
|-----------------------------------|-----------------|
| Storage Temp Range | -65°C to +150°C |
| Max Junction Temperature (Note 3) | 150°C |
| ESD Tolerance (Notes 7, 8) | $\pm 700V$ |

Operating Ratings

| | |
|----------------------------|--|
| Temperature Range (Note 3) | |
| LM6165, LM6165J/883 | $-55^\circ C \leq T_J \leq +125^\circ C$ |
| LM6265 | $-25^\circ C \leq T_J \leq +85^\circ C$ |
| LM6365 | $0^\circ C \leq T_J \leq +70^\circ C$ |
| Supply Voltage Range | 4.75V to 32V |

DC Electrical Characteristics

The following specifications apply for Supply Voltage = $\pm 15V$, $V_{CM} = 0$, $R_L \geq 100\text{ k}\Omega$ and $R_S = 50\Omega$ unless otherwise noted. **Boldface** limits apply for $T_A = T_J = T_{MIN}$ to T_{MAX} ; all other limits $T_A = T_J = 25^\circ C$.

| Symbol | Parameter | Conditions | Typ | LM6165 | LM6265 | LM6365 | Units |
|-------------------|---|---|--------------|------------------------|-------------------|-------------------|------------------|
| | | | | Limit (Notes 4, 12) | Limit (Note 4) | Limit (Note 4) | |
| V_{OS} | Input Offset Voltage | | 1 | 3 | 3 | 6 | mV |
| | | | | 4 | 4 | 7 | Max |
| V_{OS} Drift | Input Offset Voltage Average Drift | | 3 | | | | $\mu V/^\circ C$ |
| I_b | Input Bias Current | | 2.5 | 3 | 3 | 5 | μA |
| | | | | 6 | 5 | 6 | Max |
| I_{OS} | Input Offset Current | | 150 | 350 | 350 | 1500 | nA |
| | | | | 800 | 600 | 1900 | Max |
| I_{OS} Drift | Input Offset Current Average Drift | | 0.3 | | | | $nA/^\circ C$ |
| R_{IN} | Input Resistance | Differential | 20 | | | | $k\Omega$ |
| C_{IN} | Input Capacitance | | 6.0 | | | | pF |
| A_{VOL} | Large Signal Voltage Gain (Note 10) | $V_{OUT} = \pm 10V$, $R_L = 2\text{ k}\Omega$ | 10.5 | 7.5 | 7.5 | 5.5 | V/mV |
| | | $R_L = 10\text{ k}\Omega$ | 38 | 5.0 | 6.0 | 5.0 | Min |
| V_{CM} | Input Common-Mode Voltage Range | Supply = $\pm 15V$ | +14.0 | +13.9 | +13.9 | +13.8 | V |
| | | | | +13.8 | +13.8 | +13.7 | Min |
| | | | -13.6 | -13.4 | -13.4 | -13.3 | V |
| | | | -13.2 | -13.2 | -13.2 | Min | |
| | | Supply = +5V (Note 5) | 4.0 | 3.9 | 3.9 | 3.8 | V |
| | 3.8 | | 3.8 | 3.7 | Min | | |
| | | 1.4 | 1.6 | 1.6 | 1.7 | V | |
| | | | 1.8 | 1.8 | 1.8 | Max | |
| CMRR | Common-Mode Rejection Ratio | $-10V \leq V_{CM} \leq +10V$ | 102 | 88 | 88 | 80 | dB |
| | | | | 82 | 84 | 78 | Min |
| PSRR | Power Supply Rejection Ratio | $\pm 10V \leq V^{\pm} \leq \pm 16V$ | 104 | 88 | 88 | 80 | dB |
| | | | | 82 | 84 | 78 | Min |

DC Electrical Characteristics (Continued)

The following specifications apply for Supply Voltage = $\pm 15\text{V}$, $V_{\text{CM}} = 0$, $R_{\text{L}} \geq 100\text{ k}\Omega$ and $R_{\text{S}} = 50\Omega$ unless otherwise noted. **Boldface** limits apply for $T_{\text{A}} = T_{\text{J}} = T_{\text{MIN}}$ to T_{MAX} ; all other limits $T_{\text{A}} = T_{\text{J}} = 25^{\circ}\text{C}$.

| Symbol | Parameter | Conditions | Typ | LM6165 | LM6265 | LM6365 | Units |
|----------------|--|--|-------------------|------------------------|-----------------------|-----------------------|-----------|
| | | | | Limit (Notes 4, 12) | Limit (Note 4) | Limit (Note 4) | |
| V_{O} | Output Voltage Swing | Supply = $\pm 15\text{V}$, $R_{\text{L}} = 2\text{ k}\Omega$ | +14.2 | +13.5 +13.3 | +13.5 +13.3 | +13.4 +13.3 | V Min |
| | | | -13.4 | -13.0 -12.7 | -13.0 -12.8 | -12.9 -12.8 | V Min |
| | Supply = +5V $R_{\text{L}} = 2\text{ k}\Omega$ (Note 5) | 4.2 | 3.5 3.3 | 3.5 3.3 | 3.4 3.3 | V Min | |
| | | 1.3 | 1.7 2.0 | 1.7 1.9 | 1.8 1.9 | V Max | |
| | Output Short Circuit Current | Source | 65 | 30 20 | 30 25 | 30 25 | mA Min |
| | | Sink | 65 | 30 20 | 30 25 | 30 25 | mA Min |
| I_{S} | Supply Current | | 5.0 | 6.5 6.8 | 6.5 6.7 | 6.8 6.9 | mA Max |

AC Electrical Characteristics

The following specifications apply for Supply Voltage = $\pm 15\text{V}$, $V_{\text{CM}} = 0$, $R_{\text{L}} \geq 100\text{ k}\Omega$ and $R_{\text{S}} = 50\Omega$ unless otherwise noted. **Boldface** limits apply for $T_{\text{A}} = T_{\text{J}} = T_{\text{MIN}}$ to T_{MAX} ; all other limits $T_{\text{A}} = T_{\text{J}} = 25^{\circ}\text{C}$. (Note 6)

| Symbol | Parameter | Conditions | Typ | LM6165 | LM6265 | LM6365 | Units |
|-------------------|-------------------------|--|------|------------------------|-------------------|-------------------|-------------------------|
| | | | | Limit (Notes 4, 12) | Limit (Note 4) | Limit (Note 4) | |
| GBW | Gain Bandwidth | F = 20 MHz | 725 | 575 350 | 575 | 500 | MHz Min |
| | Product | Supply = $\pm 5\text{V}$ | 500 | | | | |
| SR | Slew Rate | $A_{\text{V}} = +25$ (Note 9) | 300 | 200 180 | 200 | 200 | V/ μs Min |
| | | Supply = $\pm 5\text{V}$ | 200 | | | | |
| PBW | Power Bandwidth Product | $V_{\text{OUT}} = 20 V_{\text{PP}}$ | 4.5 | | | | MHz |
| t_{S} | Settling Time | 10V Step to 0.1% $A_{\text{V}} = -25$, $R_{\text{L}} = 2\text{ k}\Omega$ | 80 | | | | ns |
| ϕ_{m} | Phase Margin | $A_{\text{V}} = +25$ | 45 | | | | Deg |
| A_{D} | Differential Gain | NTSC, $A_{\text{V}} = +25$ | <0.1 | | | | % |
| ϕ_{D} | Differential Phase | NTSC, $A_{\text{V}} = +25$ | <0.1 | | | | Deg |
| $e_{\text{np-p}}$ | Input Noise Voltage | F = 10 kHz | 5 | | | | nV/ $\sqrt{\text{Hz}}$ |
| $i_{\text{np-p}}$ | Input Noise Current | F = 10 kHz | 1.5 | | | | pA/ $\sqrt{\text{Hz}}$ |

Note 1: "Absolute Maximum Ratings" indicate limits beyond which damage to the device may occur. Operating Ratings indicate conditions for which the device is functional, but do not guarantee specific performance limits.

Note 2: Continuous short-circuit operation at elevated ambient temperature can result in exceeding the maximum allowed junction temperature of 150°C .

Note 3: The typical junction-to-ambient thermal resistance of the molded plastic DIP (N) is $105^{\circ}\text{C}/\text{Watt}$, and the molded plastic SO (M) package is $155^{\circ}\text{C}/\text{Watt}$, and the cerdip (J) package is $125^{\circ}\text{C}/\text{Watt}$. All numbers apply for packages soldered directly into a printed circuit board.

Note 4: All limits guaranteed by testing or correlation.

Note 5: For single supply operation, the following conditions apply: $V_{+} = 5\text{V}$, $V_{-} = 0\text{V}$, $V_{\text{CM}} = 2.5\text{C}$, $V_{\text{OUT}} = 2.5\text{V}$. Pin 1 & Pin 8 (V_{OS} Adjust) are each connected to Pin 4 (V_{-}) to realize maximum output swing. This connection will degrade V_{OS} .

Note 6: $C_{\text{L}} \leq 5\text{ pF}$.

Note 7: In order to achieve optimum AC performance, the input stage was designed without protective clamps. Exceeding the maximum differential input voltage results in reverse breakdown of the base-emitter junction of one of the input transistors and probable degradation of the input parameters (especially V_{OS} , I_{OS} , and Noise).

AC Electrical Characteristics (Continued)

Note 8: The average voltage that the weakest pin combinations (those involving Pin 2 or Pin 3) can withstand and still conform to the datasheet limits. The test circuit used consists of the human body model of 100 pF in series with 1500Ω.

Note 9: $V_{IN} = 0.8V$ step. For supply = $\pm 5V$, $V_{IN} = 0.2V$ step.

Note 10: Voltage Gain is the total output swing (20V) divided by the input signal required to produce that swing.

Note 11: The voltage between V^+ and either input pin must not exceed 36V.

Note 12: A military RETS electrical test specification is available on request. At the time of printing, the LM6165J/883 RETS spec complied with the Boldface limits in this column. The LM6165J/883 may also be procured as Standard Military Drawing #5962-8962501PA.

Typical Performance Characteristics $R_L = 10\text{ k}\Omega$, $T_A = 25^\circ\text{C}$ unless otherwise specified

Supply Current vs Supply Voltage

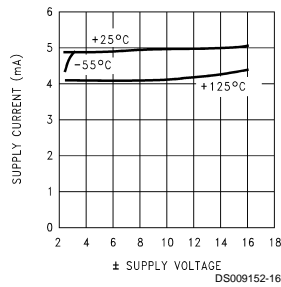

Common-Mode Rejection Ratio

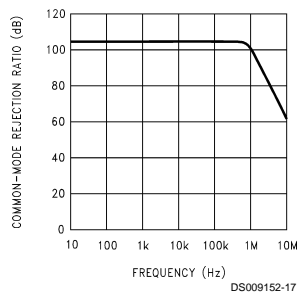

Power Supply Rejection Ratio

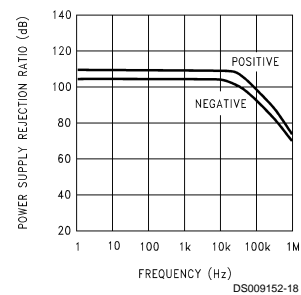

Gain-Bandwidth Product

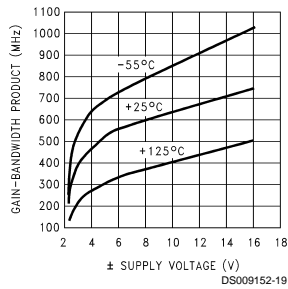

Propagation Delay, Rise and Fall Times

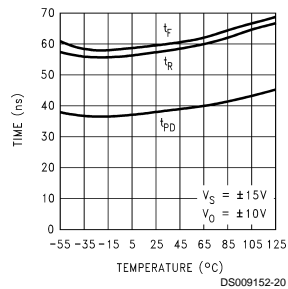

Gain-Bandwidth Product vs Load Capacitance

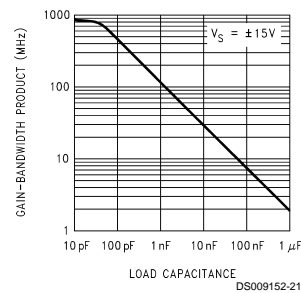

Slew Rate vs Load Capacitance

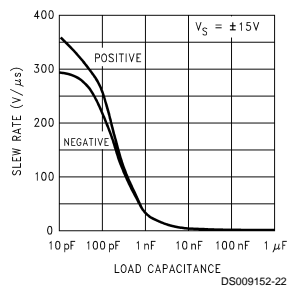

Overshoot vs Capacitive Load

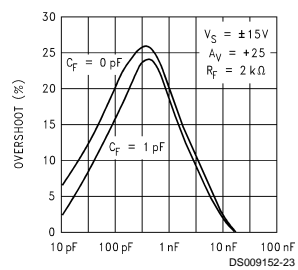

Slew Rate

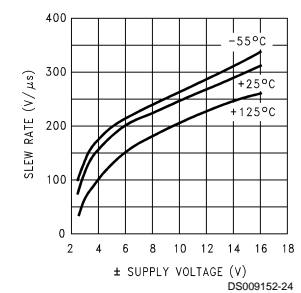

Typical Performance Characteristics $R_L = 10\text{ k}\Omega$, $T_A = 25^\circ\text{C}$ unless otherwise specified (Continued)

Output Impedance (Open-Loop)

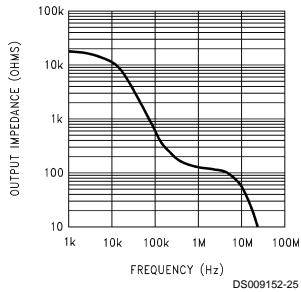

Gain vs Supply Voltage

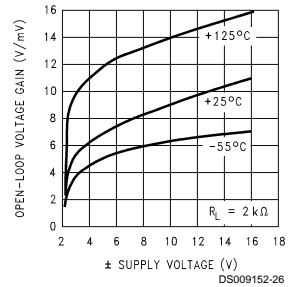

Differential Gain (Note 13)

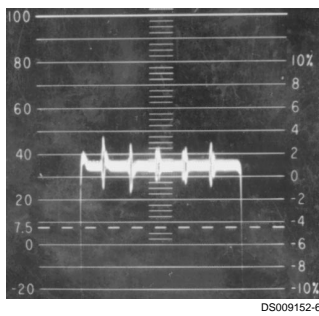

Differential Phase (Note 13)

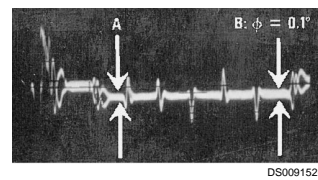

Note 13: Differential gain and differential phase measured for four series LM6365 op amps configured with gain of +25 (each output attenuated by 96%), in series with an LM6321 buffer. Error added by LM6321 is negligible. Test performed using Tektronix Type 520 NTSC test system.

Step Response; $A_v = +25$

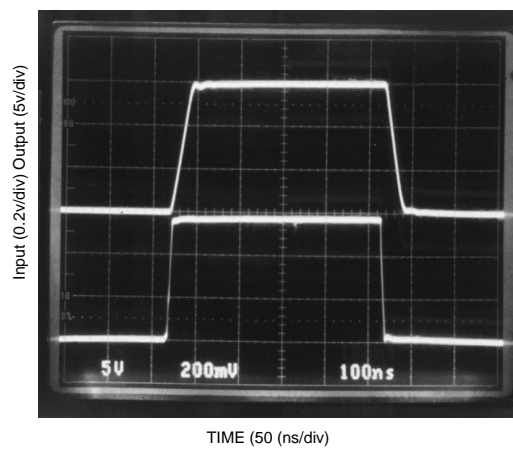

Typical Performance Characteristics $R_L = 10\text{ k}\Omega$, $T_A = 25^\circ\text{C}$ unless otherwise specified (Continued)

Input Noise Voltage

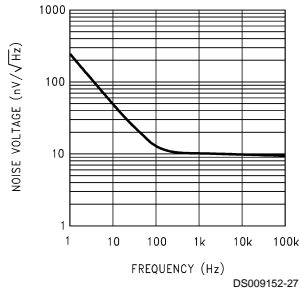

Input Noise Current

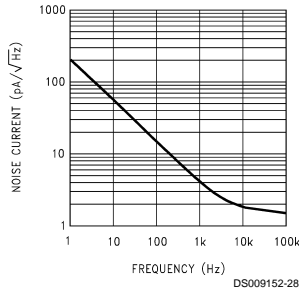

Power Bandwidth

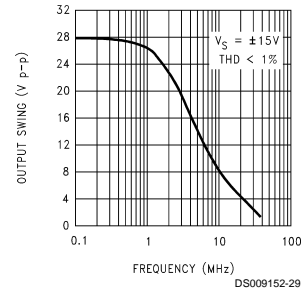

Open-Loop Frequency Response

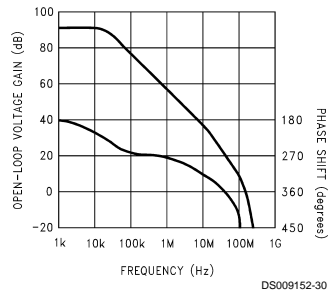

Open-Loop Frequency Response

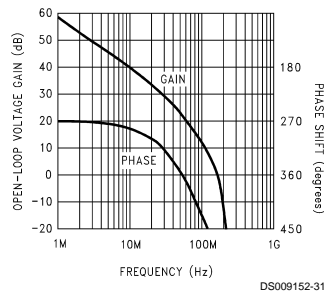

Voltage Gain vs Load Resistance

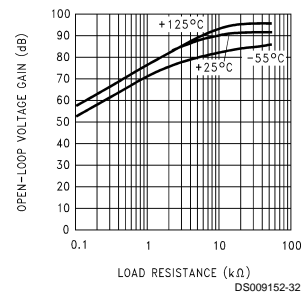

Common-Mode Input Saturation Voltage

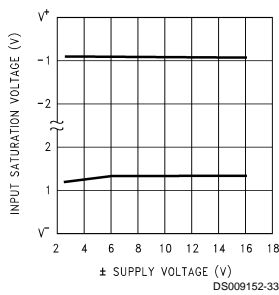

Output Saturation Voltage

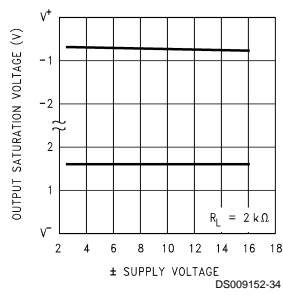

Bias Current vs Common-Mode Voltage

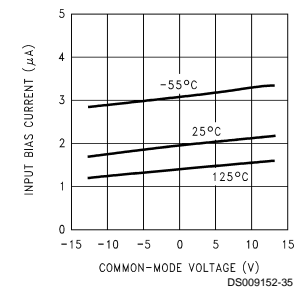

Simplified Schematic

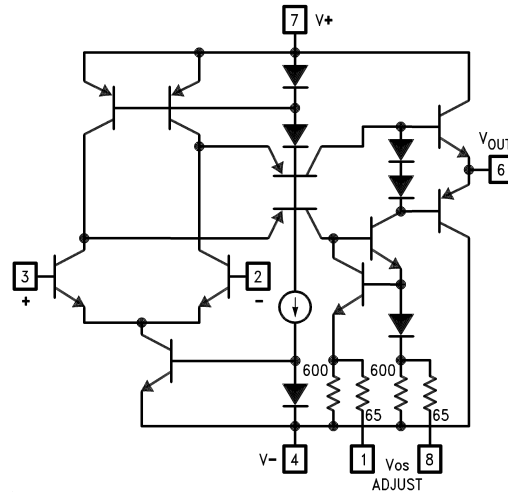

Application Tips

The LM6365 is stable for gains of 25 or greater. The LM6361 and LM6364, specified in separate datasheets, are compensated versions of the LM6365. The LM6361 is unity-gain stable, while the LM6364 is stable for gains as low as 5. The LM6361, and LM6364 have the same high slew rate as the LM6365, typically 300 V/μs.

To use the LM6365 for gains less than 25, a series resistor-capacitor network should be added between the input pins (as shown in the Typical Applications, Noise Gain Compensation) so that the high-frequency noise gain rises to at least 25.

Power supply bypassing will improve stability and transient response of the LM6365, and is recommended for every design. 0.01 μF to 0.1 μF ceramic capacitors should be used

(from each supply “rail” to ground); an additional 2.2 μF (tantalum) may be required for extra noise reduction. Keep all leads short to reduce stray capacitance and lead inductance, and make sure ground paths are low-impedance, especially where heavier currents will be flowing. Stray capacitance in the circuit layout can cause signal coupling between adjacent nodes, and can cause circuit gain to unintentionally vary with frequency.

Breadboarded circuits will work best if they are built using generic PC boards with a good ground plane. If the op amps are used with sockets, as opposed to being soldered into the circuit, the additional input capacitance may degrade circuit performance.

Typical Applications

Offset Voltage Adjustment

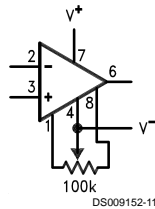

Noise-Gain Compensation

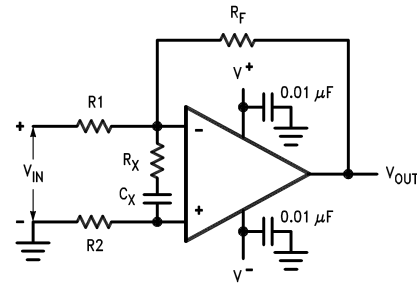

$$R_X C_X \geq 1/(2\pi \cdot 25 \text{ MHz})$$

$$[R_1 + R_F (1 + R_1/R_2)] = 25 R_X$$

DS009152-12

Typical Applications (Continued)

1 MHz Voltage-to-Frequency Converter
 ($f_{OUT} = 1 \text{ MHz}$ for $V_{IN} = 10\text{V}$)

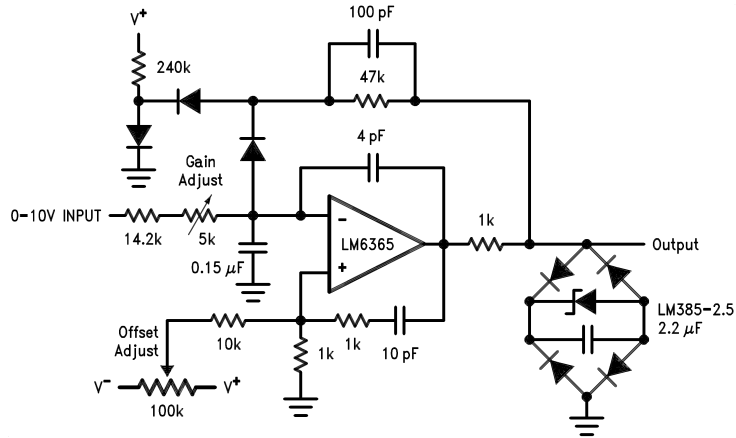

DS009152-13

All diodes 1N914

Physical Dimensions inches (millimeters) unless otherwise noted

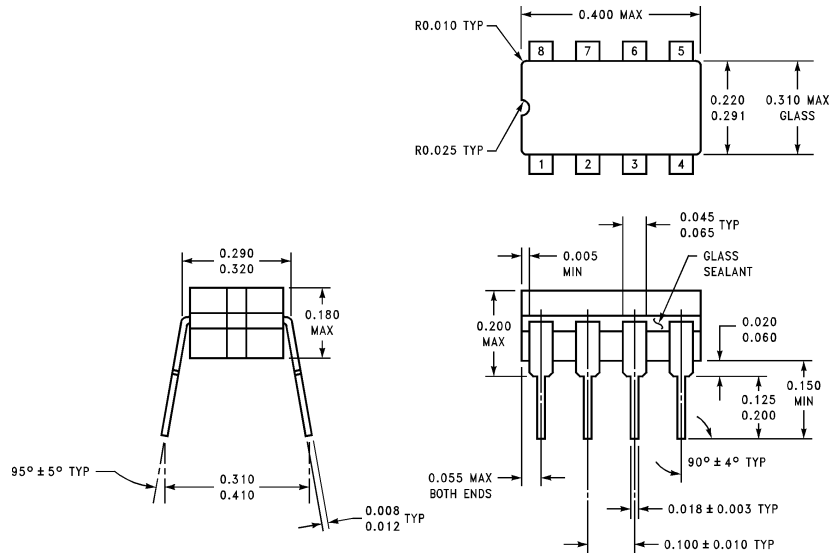

J08A (REV K)

Ceramic Dual-In-Line Package (J)
Order Number LM6165J/883
NS Package Number J08A

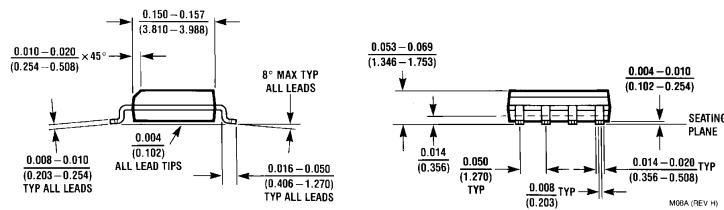
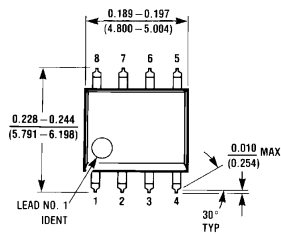

M08A (REV H)

Molded Package SO (M)
Order Number LM6365M
NS Package Number M08A

Physical Dimensions inches (millimeters) unless otherwise noted (Continued)

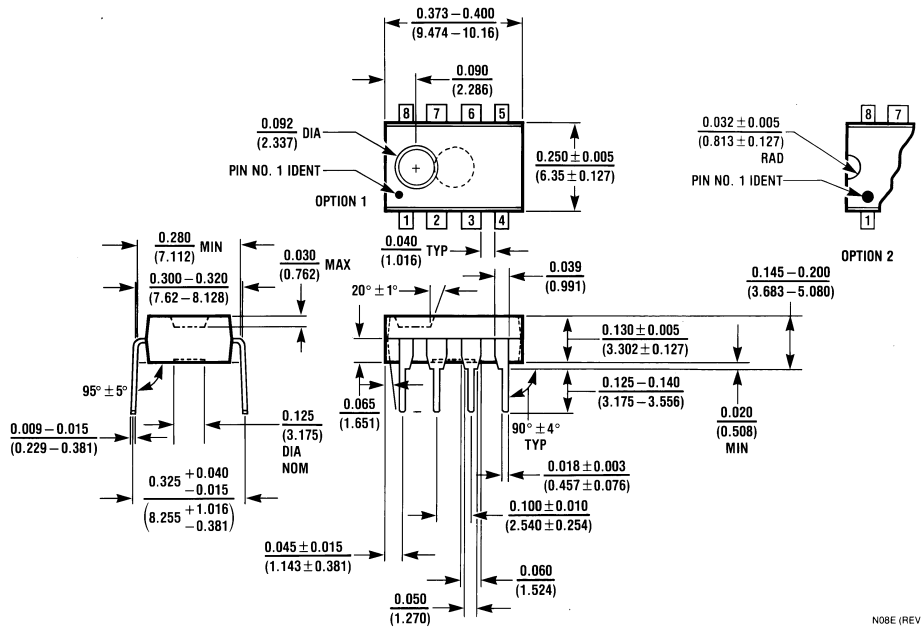

Molded Dual-In-Line Package (N)
Order Number LM6265N or LM6365N
NS Package Number N08E

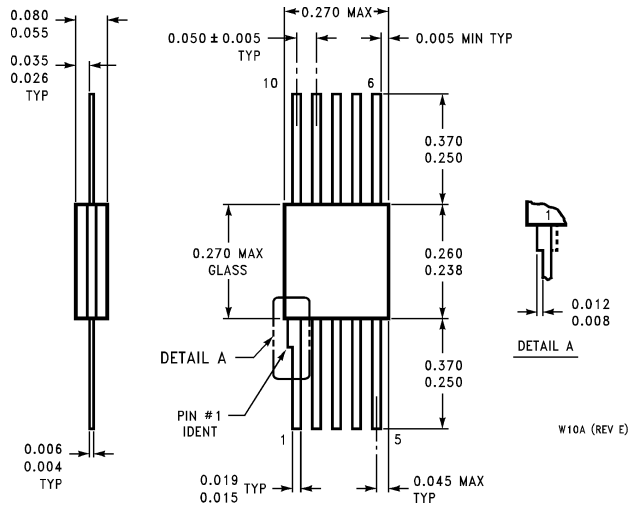

10-Pin Ceramic Flatpak
Order Number LM6165W/883
NS Package Number W10A

Notes

LIFE SUPPORT POLICY

NATIONAL'S PRODUCTS ARE NOT AUTHORIZED FOR USE AS CRITICAL COMPONENTS IN LIFE SUPPORT DEVICES OR SYSTEMS WITHOUT THE EXPRESS WRITTEN APPROVAL OF THE PRESIDENT AND GENERAL COUNSEL OF NATIONAL SEMICONDUCTOR CORPORATION. As used herein:

1. Life support devices or systems are devices or systems which, (a) are intended for surgical implant into the body, or (b) support or sustain life, and whose failure to perform when properly used in accordance with instructions for use provided in the labeling, can be reasonably expected to result in a significant injury to the user.
2. A critical component is any component of a life support device or system whose failure to perform can be reasonably expected to cause the failure of the life support device or system, or to affect its safety or effectiveness.



National Semiconductor Corporation
Americas
Tel: 1-800-272-9959
Fax: 1-800-737-7018
Email: support@nsc.com

www.national.com

National Semiconductor Europe
Fax: +49 (0) 1 80-530 85 86
Email: europe.support@nsc.com
Deutsch Tel: +49 (0) 1 80-530 85 85
English Tel: +49 (0) 1 80-532 78 32
Français Tel: +49 (0) 1 80-532 93 58
Italiano Tel: +49 (0) 1 80-534 16 80

National Semiconductor Asia Pacific Customer Response Group
Tel: 65-2544466
Fax: 65-2504466
Email: sea.support@nsc.com

National Semiconductor Japan Ltd.
Tel: 81-3-5639-7560
Fax: 81-3-5639-7507