

LM6164/LM6264/LM6364 High Speed Operational Amplifier

General Description

The LM6164 family of high-speed amplifiers exhibits an excellent speed-power product in delivering 300V per μ s and 175 MHz GBW (stable down to gains as low as +5) with only 5 mA of supply current. Further power savings and application convenience are possible by taking advantage of the wide dynamic range in operating supply voltage which extends all the way down to +5V.

These amplifiers are built with National's VIP™ (Vertically Integrated PNP) process which produces fast PNP transistors that are true complements to the already fast NPN devices. This advanced junction-isolated process delivers high speed performance without the need for complex and expensive dielectric isolation.

Features

- High slew rate: 300 V/ μ s
- High GBW product: 175 MHz
- Low supply current: 5 mA
- Fast settling: 100 ns to 0.1%
- Low differential gain: <0.1%
- Low differential phase: <0.1°
- Wide supply range: 4.75V to 32V
- Stable with unlimited capacitive load

Applications

- Video amplifier
- Wide-bandwidth signal conditioning
- Radar
- Sonar

Connection Diagrams

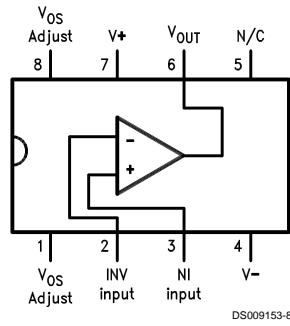

**NS Package Number
J08A, M08A or N08E**

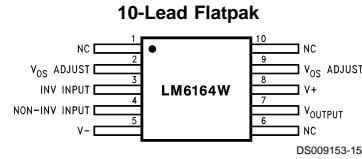

**Top View
NS Package Number W10A**

Connection Diagrams (Continued)

Temperature Range			Package	NSC Drawing
Military $-55^{\circ}\text{C} \leq T_A \leq +125^{\circ}\text{C}$	Industrial $-25^{\circ}\text{C} \leq T_A \leq +85^{\circ}\text{C}$	Commercial $0^{\circ}\text{C} \leq T_A \leq +70^{\circ}\text{C}$		
	LM6264N	LM6364N	8-Pin Molded DIP	N08E
LM6164J/883 5962-8962401PA			8-Pin Ceramic DIP	J08A
		LM6364M	8-Pin Molded Surface Mt.	M08A
LM6164WG/883 5962-8962401XA			10-Lead Ceramic SOIC	WG10A
LM6164W/883 5962-8962401HA			10-Pin Ceramic Flatpak	W10A

Absolute Maximum Ratings (Note 1)

If Military/Aerospace specified devices are required, please contact the National Semiconductor Sales Office/Distributors for availability and specifications.

Supply Voltage ($V^+ - V^-$)	36V
Differential Input Voltage (Note 7)	$\pm 8V$
Common-Mode Input Voltage (Note 11)	$(V^+ - 0.7V)$ to $(V^- + 0.7V)$
Output Short Circuit to Gnd (Note 2)	Continuous
Soldering Information	
Dual-In-Line Package (N, J)	
Soldering (10 sec.)	260°C
Small Outline Package (M)	
Vapor Phase (60 sec.)	215°C
Infrared (15 sec.)	220°C

See AN-450 "Surface Mounting Methods and Their Effect on Product Reliability" for other methods of soldering surface mount devices.

Storage Temperature Range	-65°C to +150°C
Max Junction Temperature (Note 3)	150°C
ESD Tolerance (Notes 7, 8)	$\pm 700V$

Operating Ratings

Temperature Range (Note 3)	
LM6164	$-55^\circ C \leq T_J \leq +125^\circ C$
LM6264	$-25^\circ C \leq T_J \leq +85^\circ C$
LM6364	$0^\circ C \leq T_J \leq +70^\circ C$
Supply Voltage Range	4.75V to 32V

Note 1: "Absolute Maximum Ratings" indicate limits beyond which damage to the device may occur. Operating Ratings indicate conditions for which the device is functional, but do not guarantee specific performance limits.

DC Electrical Characteristics

The following specifications apply for Supply Voltage = $\pm 15V$, $V_{CM} = 0$, $R_L \geq 100\text{ k}\Omega$ and $R_S = 50\Omega$ unless otherwise noted. **Boldface** limits apply for $T_A = T_J = T_{MIN}$ to T_{MAX} ; all other limits $T_A = T_J = 25^\circ C$.

Symbol	Parameter	Conditions	Typ	LM6164	LM6264	LM6364	Units
				Limit (Notes 4, 12)	Limit (Note 4)	Limit (Note 4)	
V_{OS}	Input Offset Voltage		2	4	4	9	mV
				6	6	11	max
V_{OS} Drift	Input Offset Voltage Average Drift		6				$\mu V/^\circ C$
I_b	Input Bias Current		2.5	3	3	5	μA
				6	5	6	max
I_{OS}	Input Offset Current		150	350	350	1500	nA
				800	600	1900	max
I_{OS} Drift	Input Offset Current Average Drift		0.3				nA/°C
R_{IN}	Input Resistance	Differential	100				k Ω
C_{IN}	Input Capacitance		3.0				pF
A_{VOL}	Large Signal Voltage Gain	$V_{OUT} = \pm 10V$, $R_L = 2\text{ k}\Omega$ (Note 10)	2.5	1.8	1.8	1.3	V/mV
		$R_L = 10\text{ k}\Omega$	9	0.9	1.2	1.1	min
V_{CM}	Input Common-Mode Voltage Range	Supply = $\pm 15V$	+14.0	+13.9	+13.9	+13.8	V
			+13.8	+13.8	+13.7	min	
		-13.5	-13.3	-13.3	-13.2	V	
		-13.1	-13.1	-13.1	min		
		Supply = +5V (Note 5)	4.0	3.9	3.9	3.8	V
			3.8	3.8	3.7	min	
			1.5	1.7	1.7	1.8	V
			1.9	1.9	1.9	max	
CMRR	Common-Mode Rejection Ratio	$-10V \leq V_{CM} \leq +10V$	105	86	86	80	dB
				80	82	78	min
PSRR	Power Supply Rejection Ratio	$\pm 10V \leq V_{\pm} \leq \pm 16V$	96	86	86	80	dB
				80	82	78	min

DC Electrical Characteristics (Continued)

The following specifications apply for Supply Voltage = $\pm 15\text{V}$, $V_{\text{CM}} = 0$, $R_{\text{L}} \geq 100\text{ k}\Omega$ and $R_{\text{S}} = 50\Omega$ unless otherwise noted. **Boldface** limits apply for $T_{\text{A}} = T_{\text{J}} = T_{\text{MIN}}$ to T_{MAX} ; all other limits $T_{\text{A}} = T_{\text{J}} = 25^{\circ}\text{C}$.

Symbol	Parameter	Conditions	Typ	LM6164	LM6264	LM6364	Units
				Limit (Notes 4, 12)	Limit (Note 4)	Limit (Note 4)	
V_{O}	Output Voltage Swing	Supply = +5V and $R_{\text{L}} = 2\text{ k}\Omega$	+14.2	+13.5 +13.3	+13.5 +13.3	+13.4 +13.3	V min
			-13.4	-13.0 -12.7	-13.0 -12.8	-12.9 -12.8	V min
		Supply = +5V and $R_{\text{L}} = 2\text{ k}\Omega$ (Note 10)	4.2	3.5 3.3	3.5 3.3	3.4 3.3	V min
			1.3	1.7 2.0	1.7 1.9	1.8 1.9	V max
	Output Short Circuit Current	Source	65	30 20	30 25	30 25	mA min
		Sink	65	30 20	30 25	30 25	mA min
I_{S}	Supply Current		5.0	6.5 6.8	6.5 6.7	6.8 6.9	mA min

AC Electrical Characteristics

The following specifications apply for Supply Voltage = $\pm 15\text{V}$, $V_{\text{CM}} = 0$, $R_{\text{L}} \geq 100\text{ k}\Omega$ and $R_{\text{S}} = 50\Omega$ unless otherwise noted. **Boldface** limits apply for $T_{\text{A}} = T_{\text{J}} = T_{\text{MIN}}$ to T_{MAX} ; all other limits $T_{\text{A}} = T_{\text{J}} = 25^{\circ}\text{C}$.

Symbol	Parameter	Conditions	Typ	LM6164	LM6264	LM6364	Units
				Limit (Notes 4, 12)	Limit (Note 4)	Limit (Note 4)	
GBW	Gain-Bandwidth Product	F = 20 MHz	175	140 100	140 120	120 100	MHz min
		Supply = $\pm 5\text{V}$	120				
SR	Slew Rate	$A_{\text{V}} = +5$ (Note 9)	300	200 180	200 180	200 180	V/ μs min
		Supply = $\pm 5\text{V}$	200				
PBW	Power Bandwidth	$V_{\text{OUT}} = 20 V_{\text{PP}}$	4.5				MHz
T_{S}	Settling Time	10V Step to 0.1% $A_{\text{V}} = -4$, $R_{\text{L}} = 2\text{ k}\Omega$	100				ns
ϕ_{m}	Phase Margin	$A_{\text{V}} = +5$	45				Deg
A_{D}	Differential Gain	NTSC, $A_{\text{V}} = +10$	<0.1				%
ϕ_{D}	Differential Phase	NTSC, $A_{\text{V}} = +10$	<0.1				Deg
$e_{\text{np-p}}$	Input Noise Voltage	F = 10 kHz	8				nV/ $\sqrt{\text{Hz}}$
$i_{\text{np-p}}$	Input Noise Current	F = 10 kHz	1.5				pA/ $\sqrt{\text{Hz}}$

Note 2: Continuous short-circuit operation at elevated ambient temperature can result in exceeding the maximum allowed junction temperature of 150°C .

Note 3: The typical junction-to-ambient thermal resistance of the molded plastic DIP (N) is $105^{\circ}\text{C}/\text{Watt}$, the molded plastic SO (M) package is $155^{\circ}\text{C}/\text{Watt}$, and the cerdip (J) package is $125^{\circ}\text{C}/\text{Watt}$. All numbers apply for packages soldered directly into a printed circuit board.

Note 4: Limits are guaranteed by testing or correlation.

Note 5: For single supply operation, the following conditions apply: $V^{+} = 5\text{V}$, $V^{-} = 0\text{V}$, $V_{\text{CM}} = 2.5\text{V}$, $V_{\text{OUT}} = 2.5\text{V}$. Pin 1 & Pin 8 (V_{OS} Adjust) are each connected to Pin 4 (V^{-}) to realize maximum output swing. This connection will degrade V_{OS} .

Note 6: $C_{\text{L}} \leq 5\text{ pF}$.

Note 7: In order to achieve optimum AC performance, the input stage was designed without protective clamps. Exceeding the maximum differential input voltage results in reverse breakdown of the base-emitter junction of one of the input transistors and probable degradation of the input parameters (especially V_{OS} , I_{OS} , and Noise).

Note 8: The average voltage that the weakest pin combinations (those involving Pin 2 or Pin 3) can withstand and still conform to the datasheet limits. The test circuit used consists of the human body model of 100 pF in series with 1500Ω .

AC Electrical Characteristics (Continued)

Note 9: $V_{IN} = 4V$ step. For supply = $\pm 5V$, $V_{IN} = 1V$ step.

Note 10: Voltage Gain is the total output swing (20V) divided by the input signal required to produce that swing.

Note 11: The voltage between V^+ and either input pin must not exceed 36V.

Note 12: A military RETS electrical test specification is available on request. At the time of printing, the LM6164J/883 RETS spec complied with the **Boldface** limits in this column. The LM6164J/883 may also be procured as Standard Military Drawing #5962-8962401PA.

Typical Performance Characteristics ($R_L = 10\text{ k}\Omega$, $T_A = 25^\circ\text{C}$ unless otherwise specified)

Supply Current vs Supply Voltage

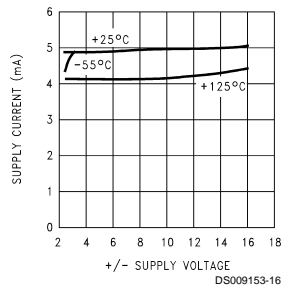

Common-Mode Rejection Ratio

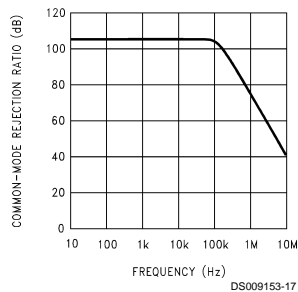

Power Supply Rejection Ratio

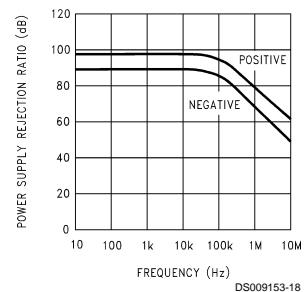

Gain-Bandwidth Product

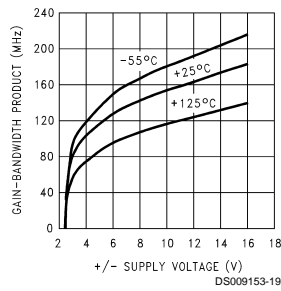

Propagation Delay Rise and Fall Time

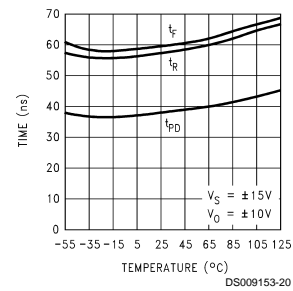

Gain-Bandwidth Product vs Load Capacitance

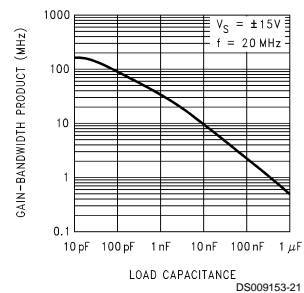

Slew Rate vs Load Capacitance

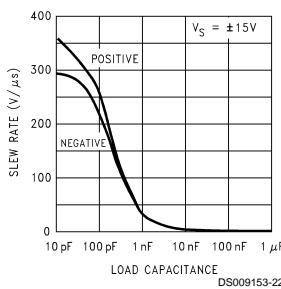

Overshoot vs Load Capacitance

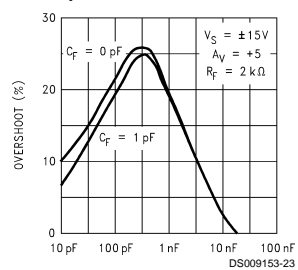

Slew Rate

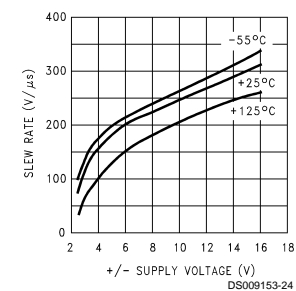

Typical Performance Characteristics ($R_L = 10\text{ k}\Omega$, $T_A = 25^\circ\text{C}$ unless otherwise specified) (Continued)

Voltage Gain vs Load Resistance

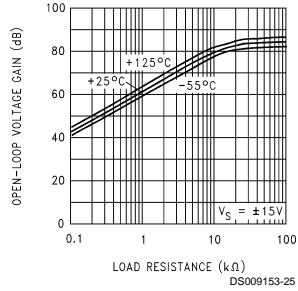

Gain vs Supply Voltage

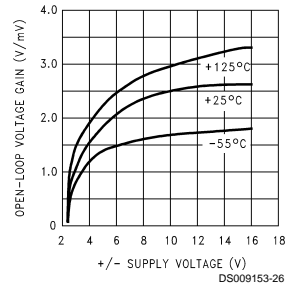

Differential Gain
(Note 13)

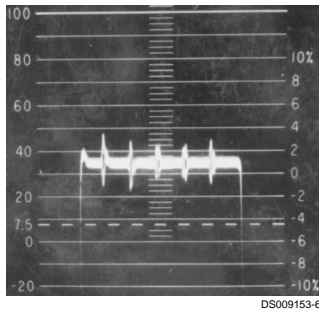

Differential Phase
(Note 13)

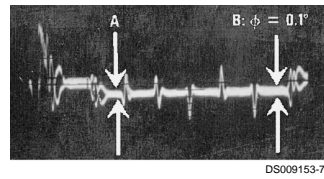

Note 13: Differential gain and differential phase measured for four series LM6364 op amps in series with an LM6321 buffer. Error added by LM6321 is negligible. Test performed using Tektronix Type 520 NTSC test system. Configured with a gain of +5 (each output attenuated by 80%)

Step Response; $A_v = +5$

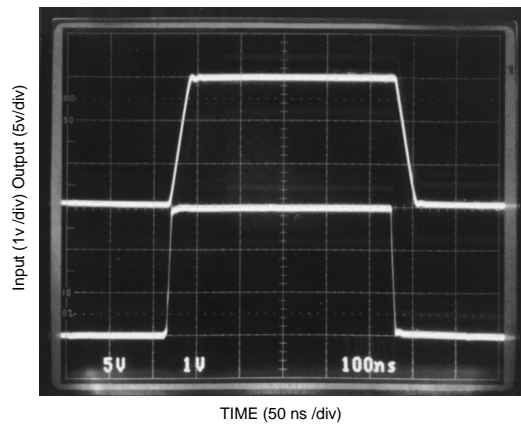

Typical Performance Characteristics ($R_L = 10\text{ k}\Omega$, $T_A = 25^\circ\text{C}$ unless otherwise specified) (Continued)

Input Noise Voltage

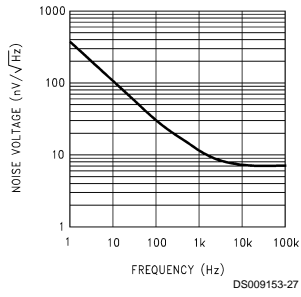

Input Noise Current

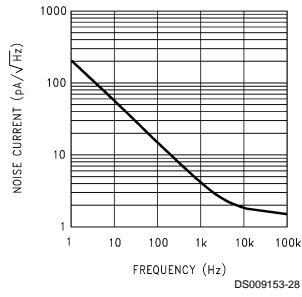

Power Bandwidth

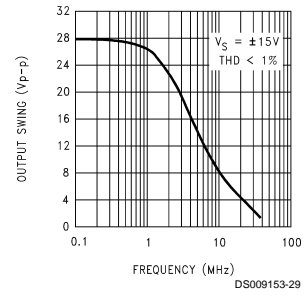

Open-Loop Frequency Response

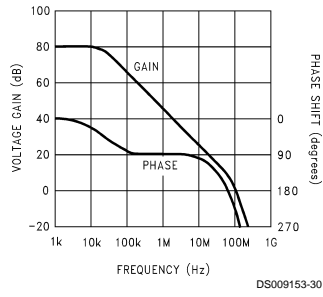

Open-Loop Frequency Response

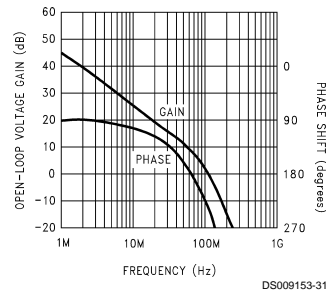

Output Resistance Open-Loop

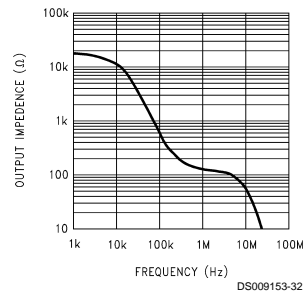

Common-Mode Input Saturation Voltage

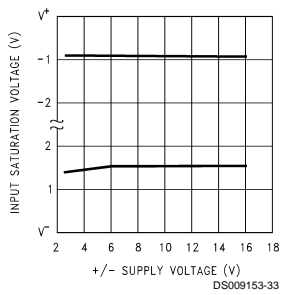

Output Saturation Voltage

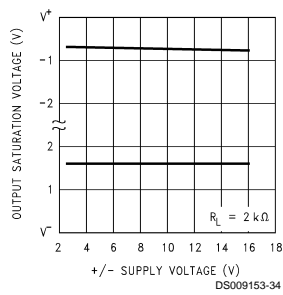

Bias Current vs Common-Mode Voltage

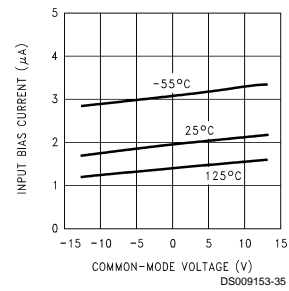

Simplified Schematic

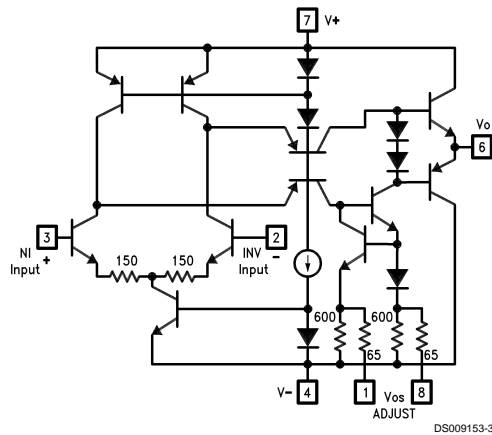

Applications Tips

The LM6364 has been compensated for gains of 5 or greater (over specified ranges of temperature, power supply voltage, and load). Since this compensation involved adding emitter-degeneration resistors in the op amp's input stage, the open-loop gain was reduced as the stability increased. Gain error due to reduced A_{VOL} is most apparent at high gains; thus, the uncompensated LM6365 is appropriate for gains of 25 or more. If unity-gain operation is desired, the LM6361 should be used. The LM6361, LM6364, and LM6365 have the same high slew rate (typically 300 V/ μ s), regardless of their compensation.

The LM6364 is unusually tolerant of capacitive loads. Most op amps tend to oscillate when their load capacitance is greater than about 200 pF (in low-gain circuits). However, load capacitance on the LM6364 effectively increases its compensation capacitance, thus slowing the op amp's response and reducing its bandwidth. The compensation is not ideal, though, and ringing or oscillation may occur in low-gain circuits with large capacitive loads. To overcompensate the LM6364 for operation at gains less than 5, a series resistor-capacitor network should be added between the input pins (as shown in the Typical Applications, Noise Gain Compensation) so that the high-frequency noise gain rises to at least 5.

Power supply bypassing will improve the stability and transient response of the LM6364, and is recommended for every design. 0.01 μ F to 0.1 μ F ceramic capacitors should be used (from each supply "rail" to ground); if the device is far away from its power supply source, an additional 2.2 μ F to 10 μ F (tantalum) may be required for extra noise reduction.

Keep all leads short to reduce stray capacitance and lead inductance, and make sure ground paths are low-impedance, especially where heavier currents will be flowing. Stray capacitance in the circuit layout can cause signal coupling between adjacent nodes, so that circuit gain unintentionally varies with frequency.

Breadboarded circuits will work best if they are built using generic PC boards with a good ground plane. If the op amps are used with sockets, as opposed to being soldered into the circuit, the additional input capacitance may degrade circuit performance.

Typical Applications

Offset Voltage Adjustment

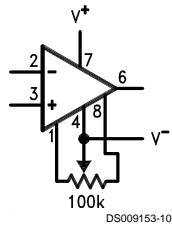

Video-Bandwidth Amplifier

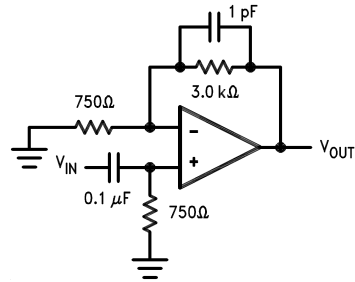

Noise-Gain Compensation for Gains ≤ 5

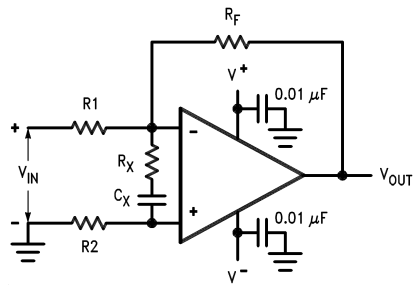

$$R_X C_X \geq (2\pi \cdot 25 \text{ MHz})^{-1}$$

$$5 R_X = R_1 + R_F(1 + R_1/R_2)$$

Physical Dimensions inches (millimeters) unless otherwise noted

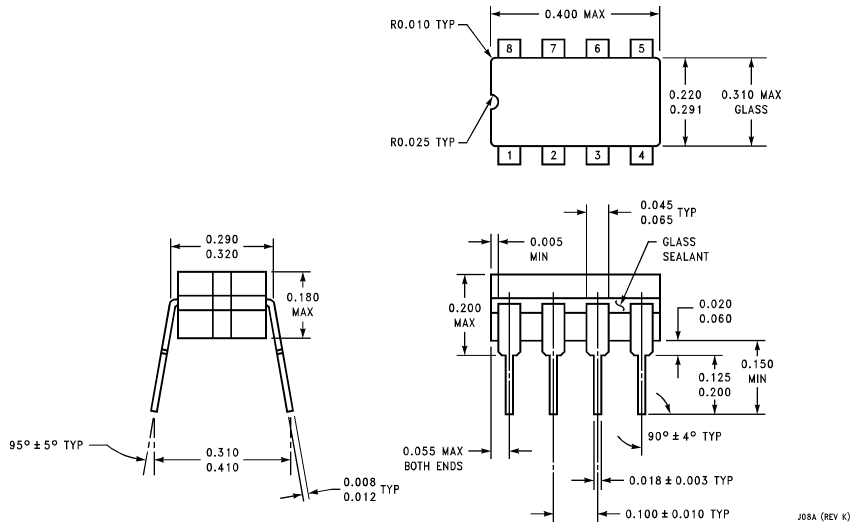

Ceramic Dual-In-Line Package (J)
Order Number LM6164J/883
NS Package Number J08A

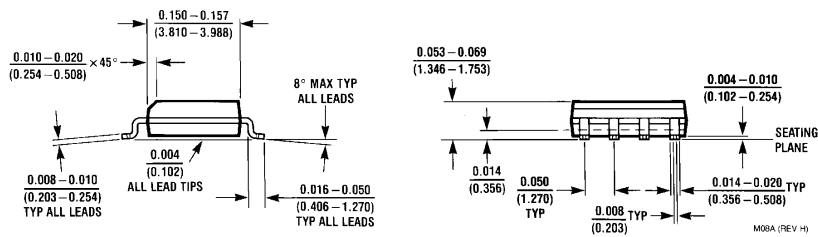
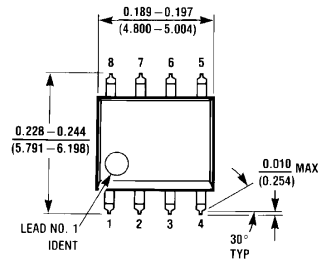

Molded Package SO (M)
Order Number LM6364M
NS Package Number M08A

Physical Dimensions inches (millimeters) unless otherwise noted (Continued)

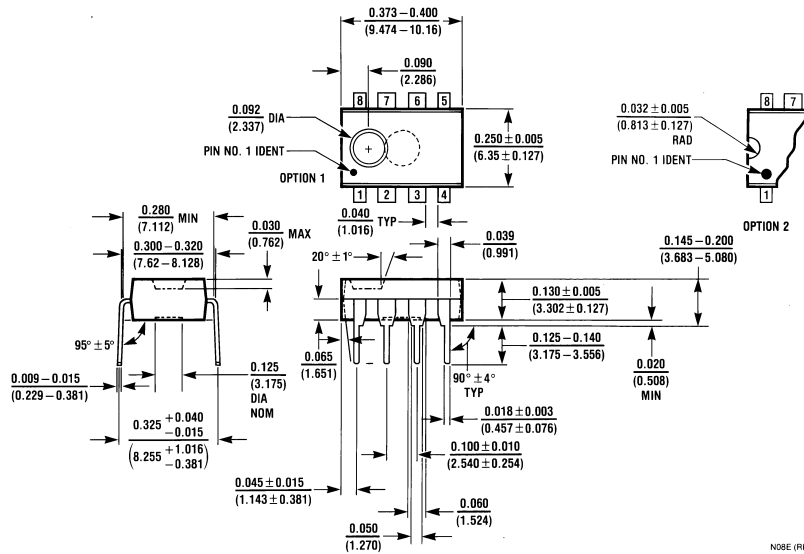

Molded Dual-In-Line Package (N)
Order Number LM6264N or LM6364N
NS Package Number N08E

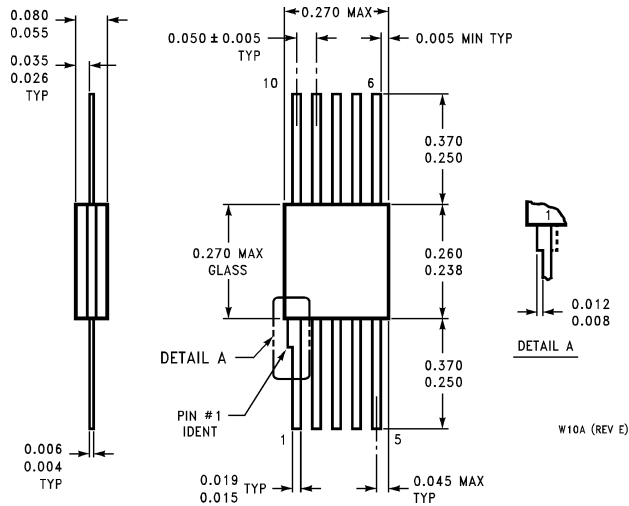

10-Pin Ceramic Flatpak
Order Number LM6164W/883
NS Package Number W10A

Notes

LIFE SUPPORT POLICY

NATIONAL'S PRODUCTS ARE NOT AUTHORIZED FOR USE AS CRITICAL COMPONENTS IN LIFE SUPPORT DEVICES OR SYSTEMS WITHOUT THE EXPRESS WRITTEN APPROVAL OF THE PRESIDENT AND GENERAL COUNSEL OF NATIONAL SEMICONDUCTOR CORPORATION. As used herein:

1. Life support devices or systems are devices or systems which, (a) are intended for surgical implant into the body, or (b) support or sustain life, and whose failure to perform when properly used in accordance with instructions for use provided in the labeling, can be reasonably expected to result in a significant injury to the user.
2. A critical component is any component of a life support device or system whose failure to perform can be reasonably expected to cause the failure of the life support device or system, or to affect its safety or effectiveness.



National Semiconductor Corporation
Americas
Tel: 1-800-272-9959
Fax: 1-800-737-7018
Email: support@nsc.com

www.national.com

National Semiconductor Europe
Fax: +49 (0) 1 80-530 85 86
Email: europe.support@nsc.com
Deutsch Tel: +49 (0) 1 80-530 85 85
English Tel: +49 (0) 1 80-532 78 32
Français Tel: +49 (0) 1 80-532 93 58
Italiano Tel: +49 (0) 1 80-534 16 80

National Semiconductor Asia Pacific Customer Response Group
Tel: 65-2544466
Fax: 65-2504466
Email: sea.support@nsc.com

National Semiconductor Japan Ltd.
Tel: 81-3-5639-7560
Fax: 81-3-5639-7507